

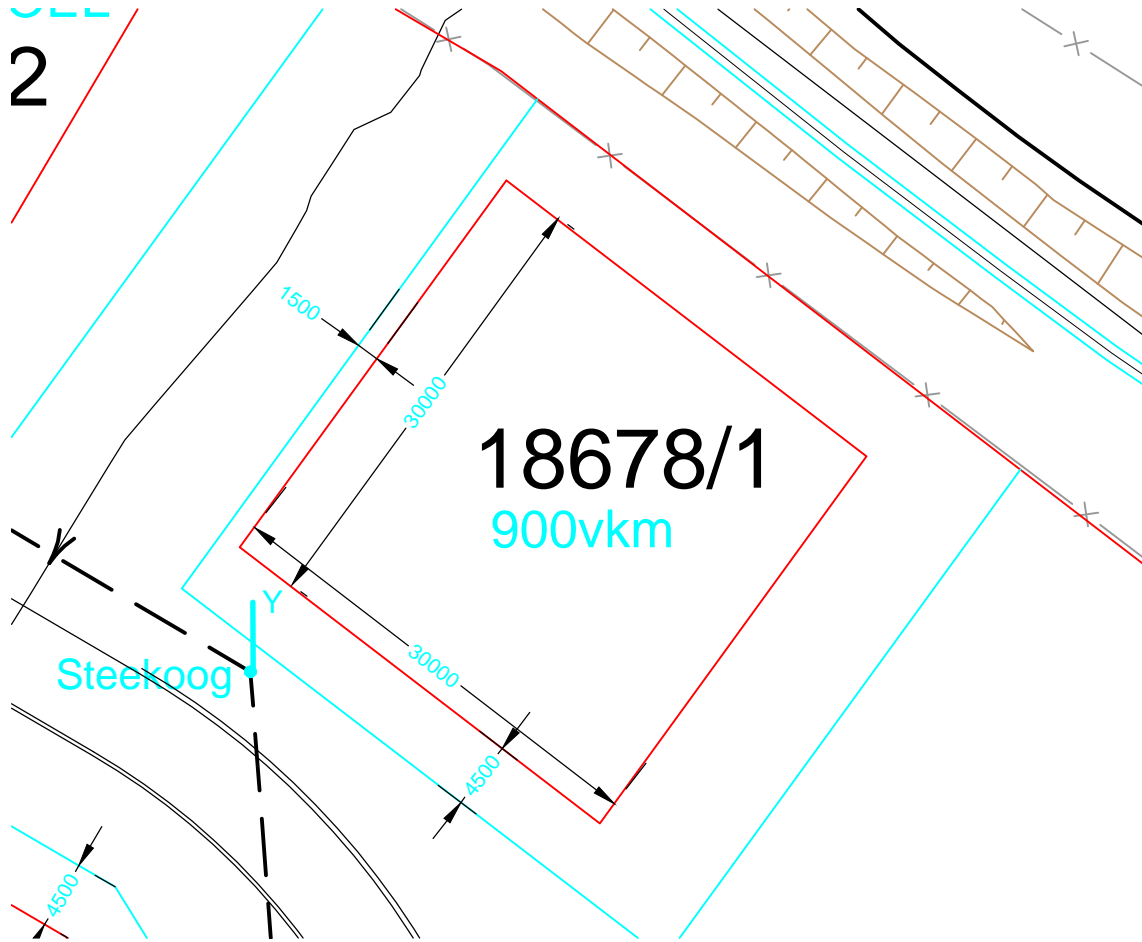

CEL  
2



DO v RENSBURG

18680

900vkm

L&J SWANEPOEL

18679/2

900vkm

Steekoog

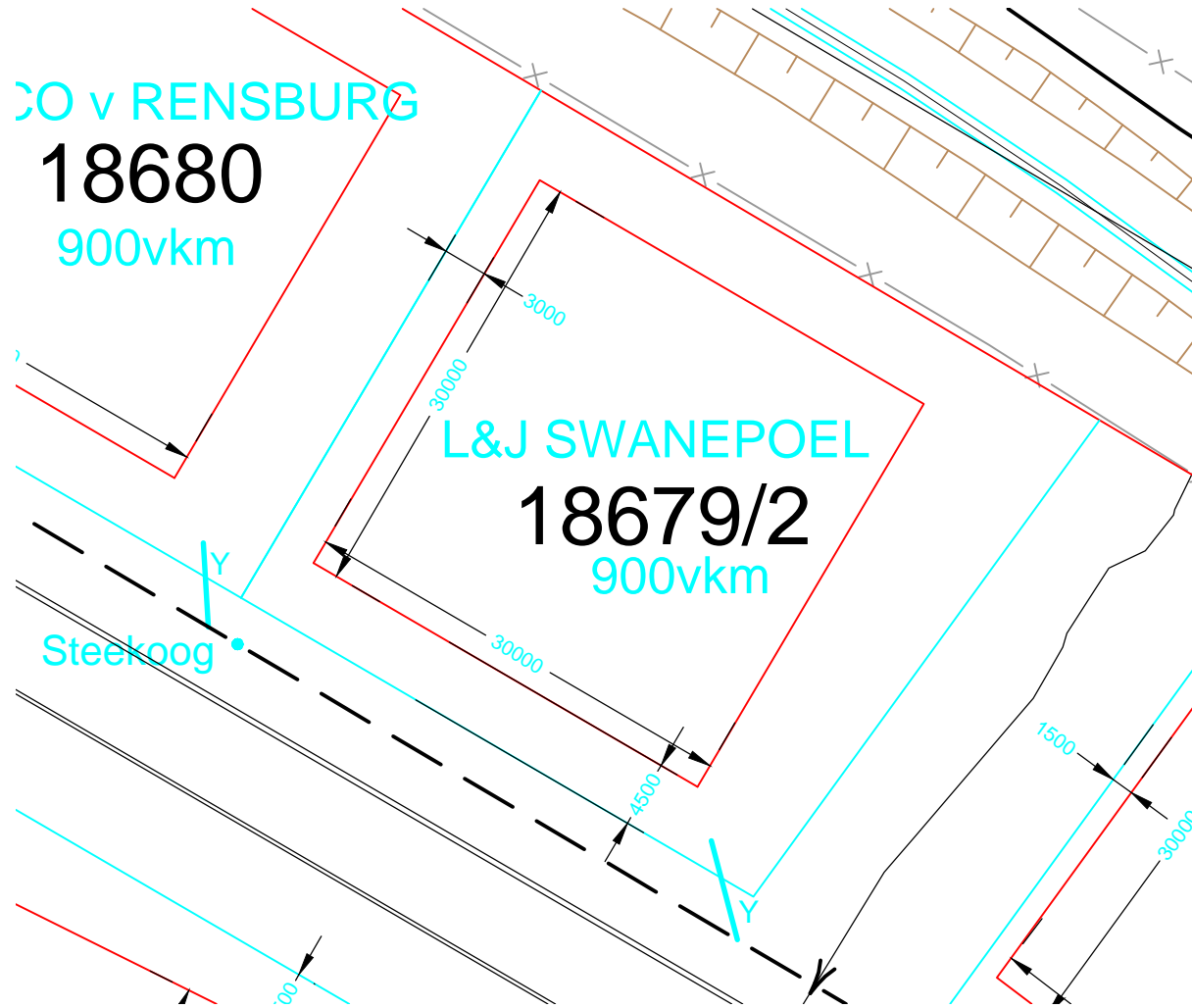

ETWA  
381/4  
vkm

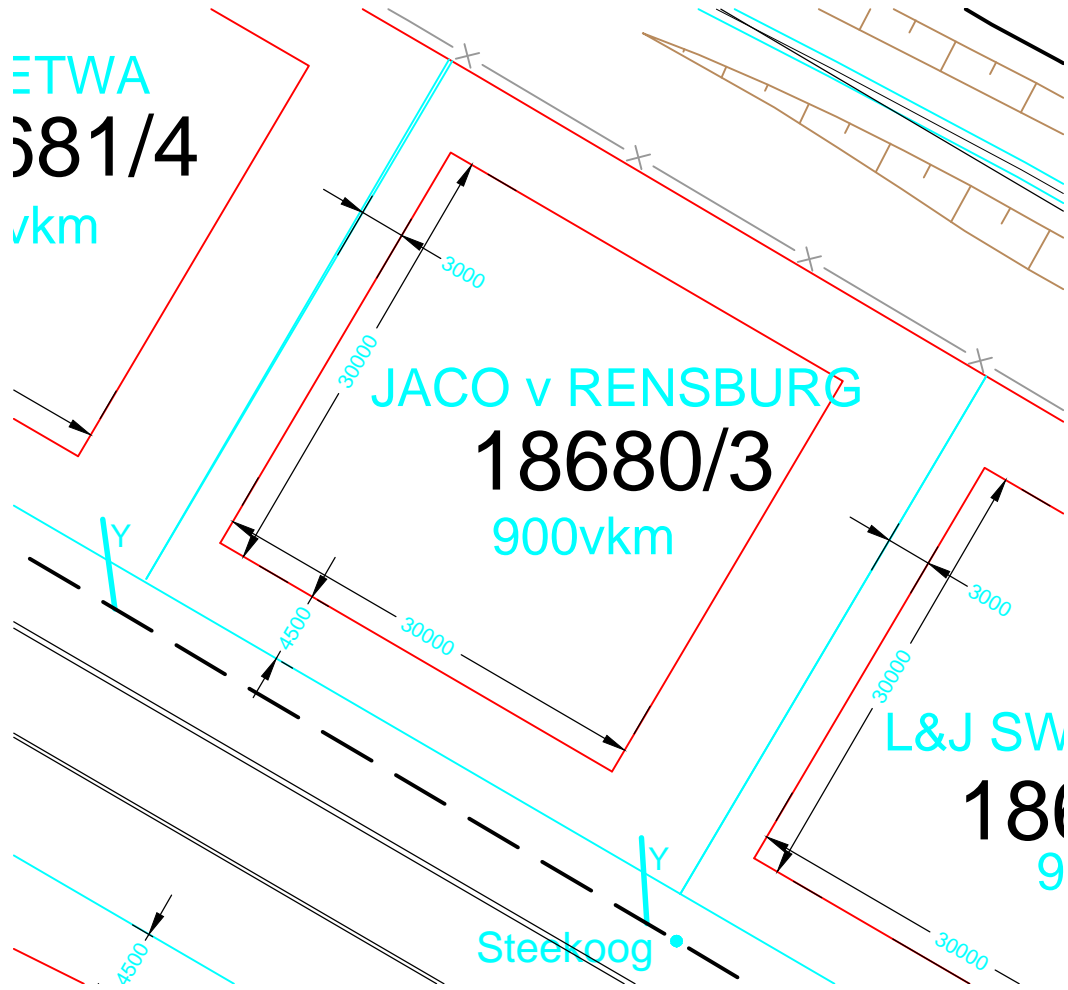

JACO v RENSBURG  
18680/3  
900vkm

L&J SW  
18680/3  
900vkm

Steekoog

MISHUYS  
3682/5  
0vkm

S MTHETWA  
18681/4  
900vkm

JACO  
1  
9

Steekoog

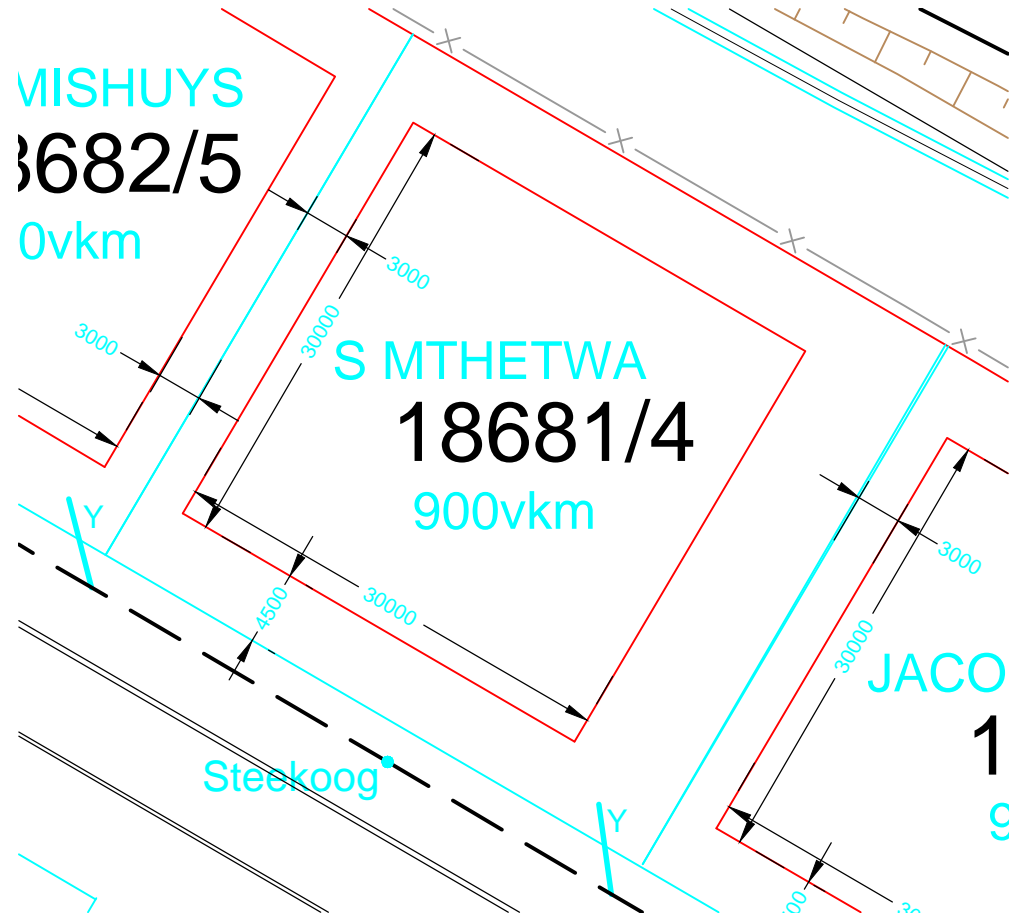

18683/6

900vkm

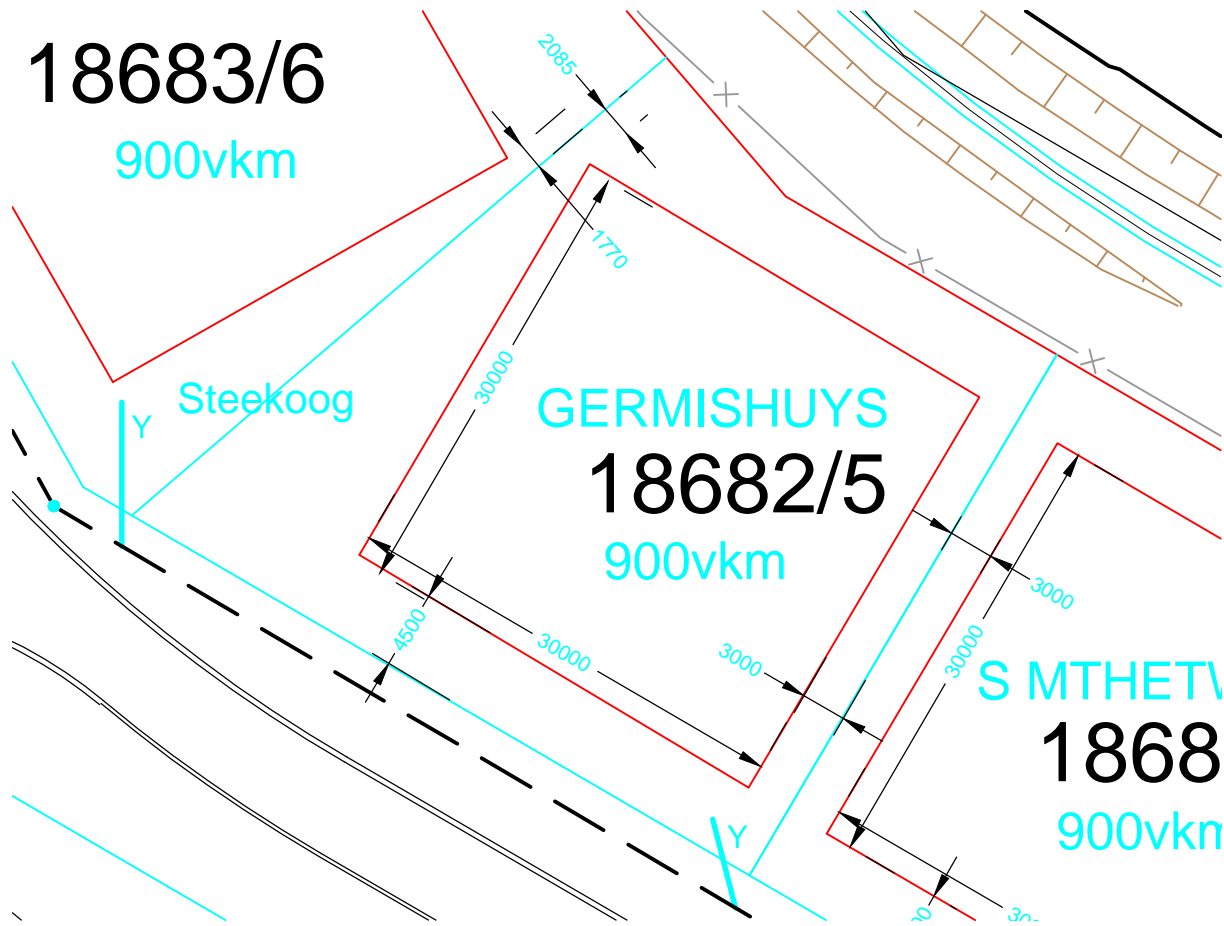

Steekoog

GERMISHUYS

18682/5

900vkm

S MTHETV

1868

900vkm

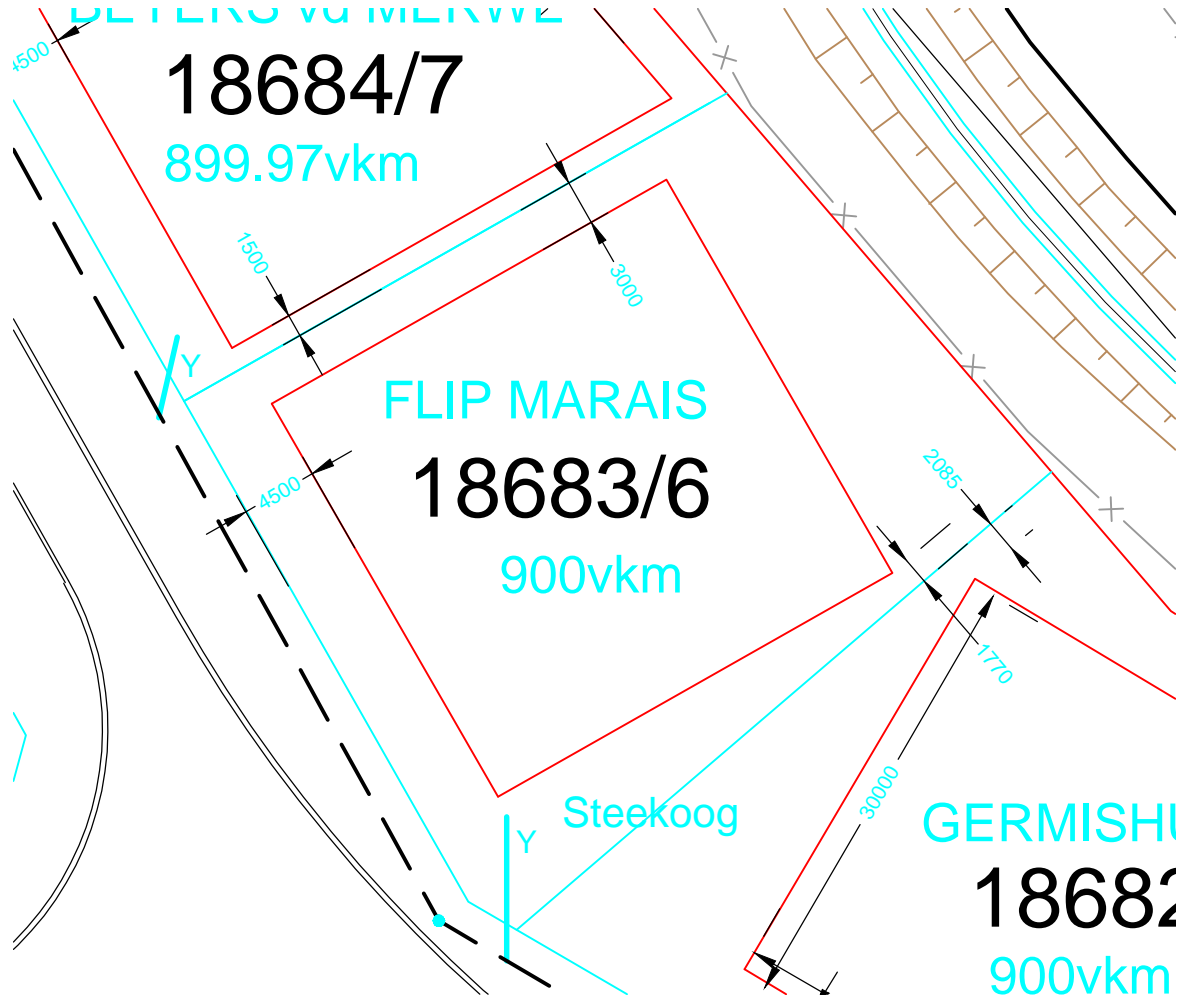

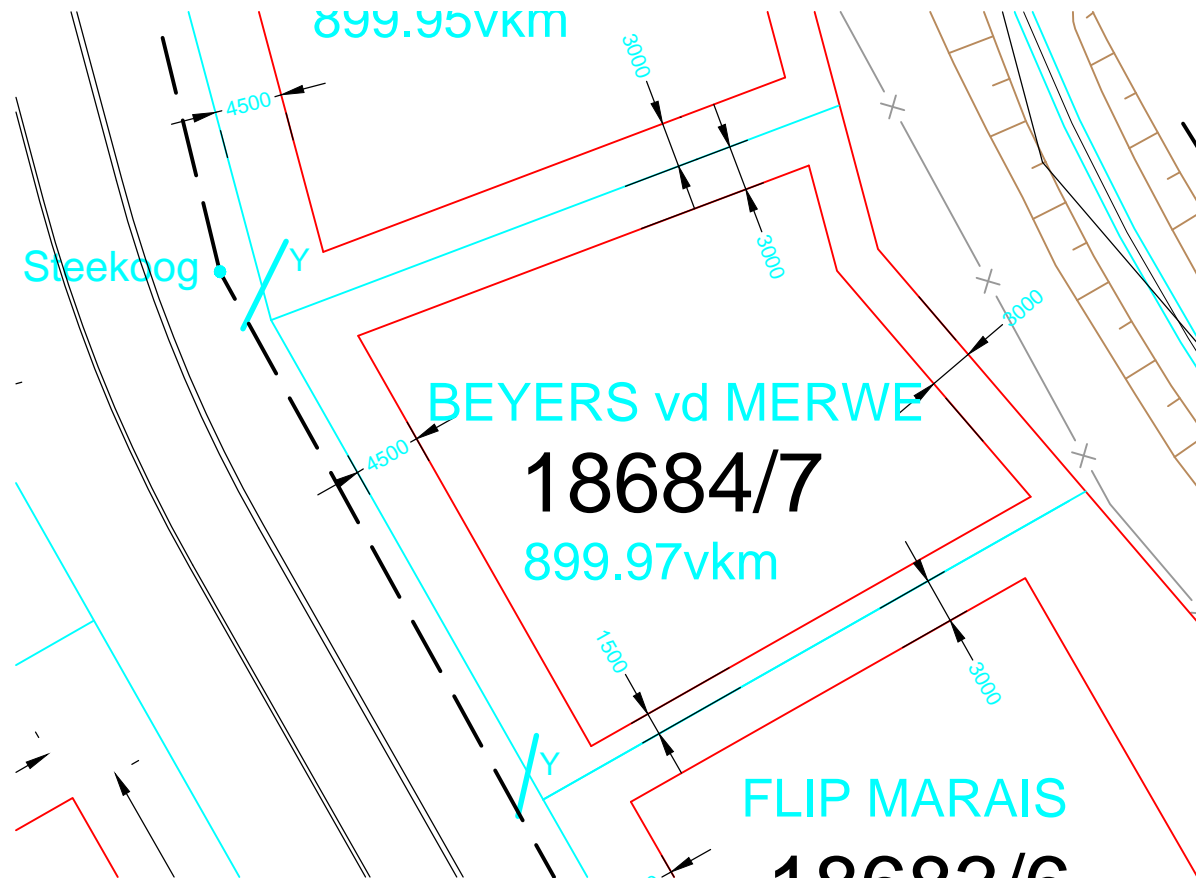



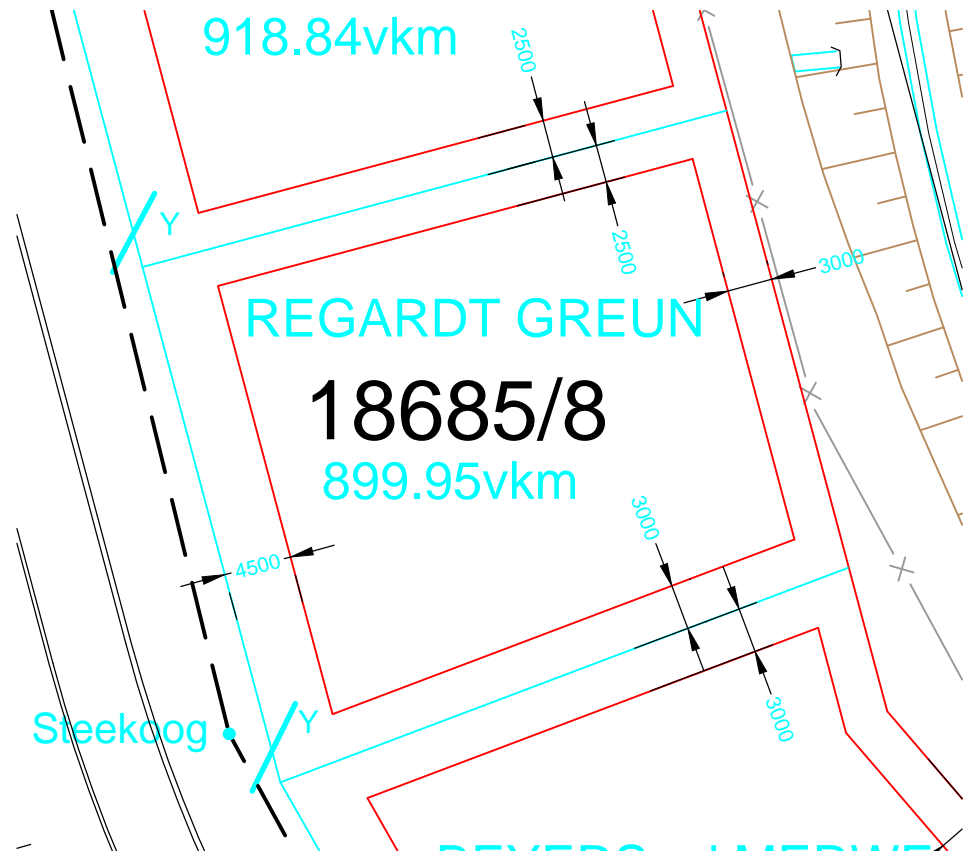





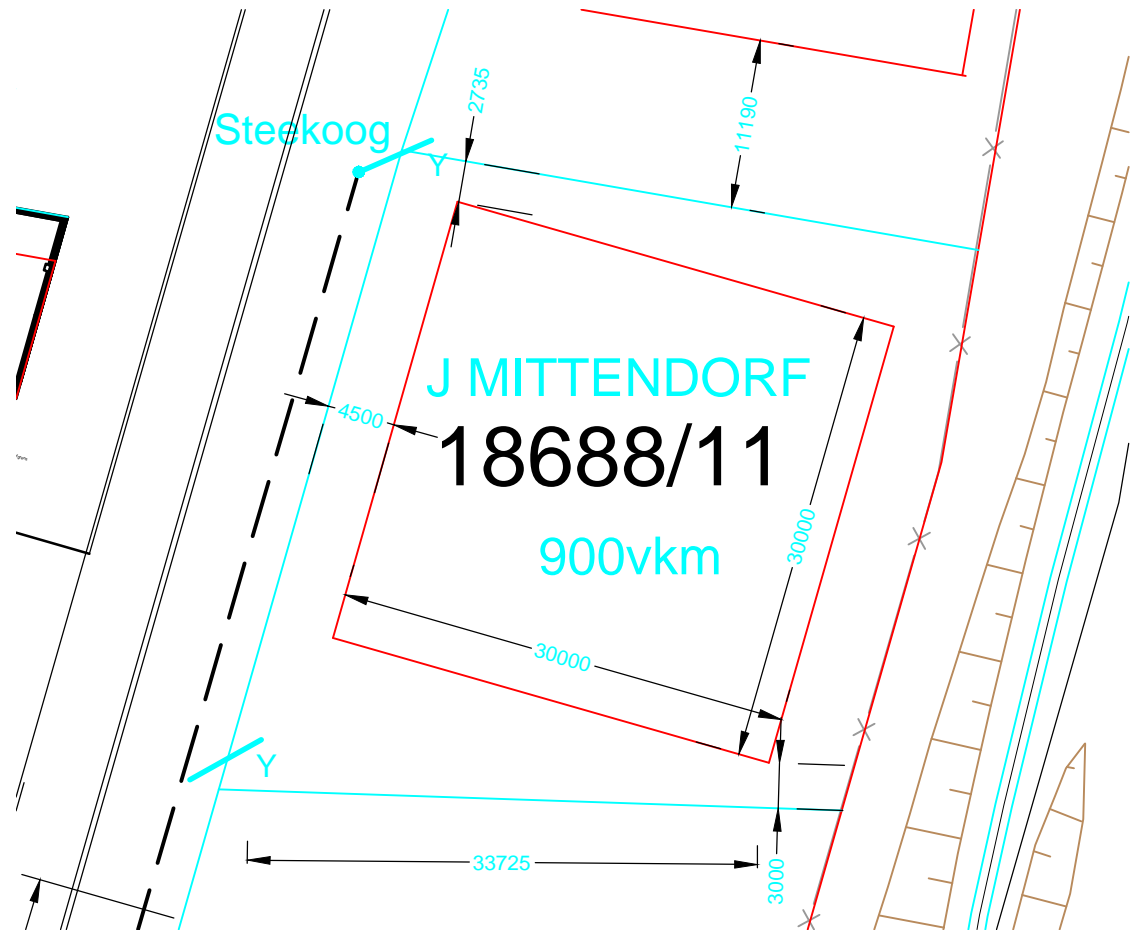

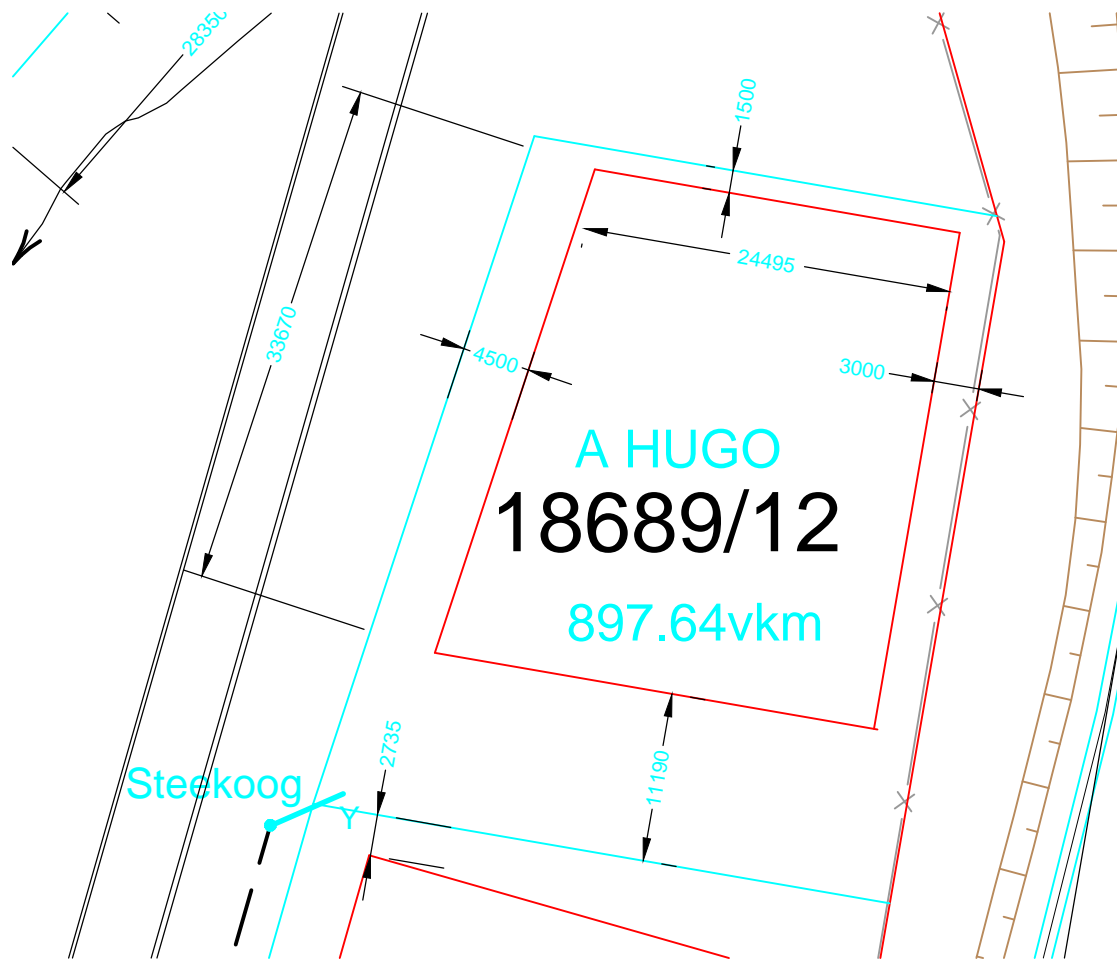

CW & PL SCHALKWYK

18690/22  
863.23vkm

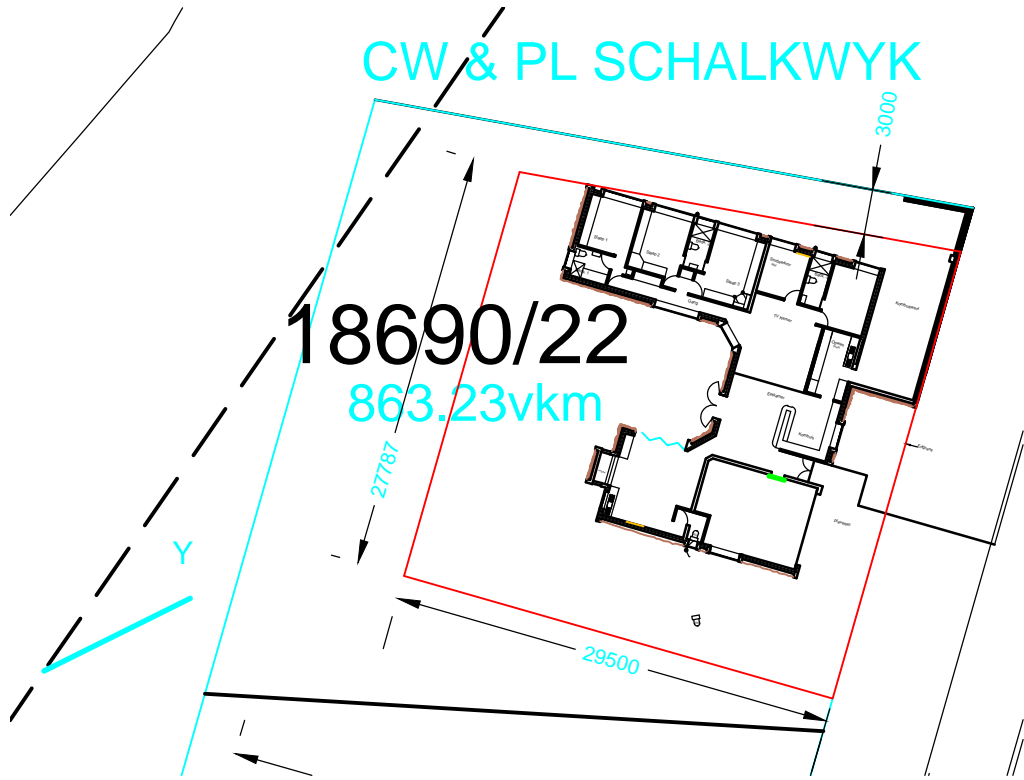

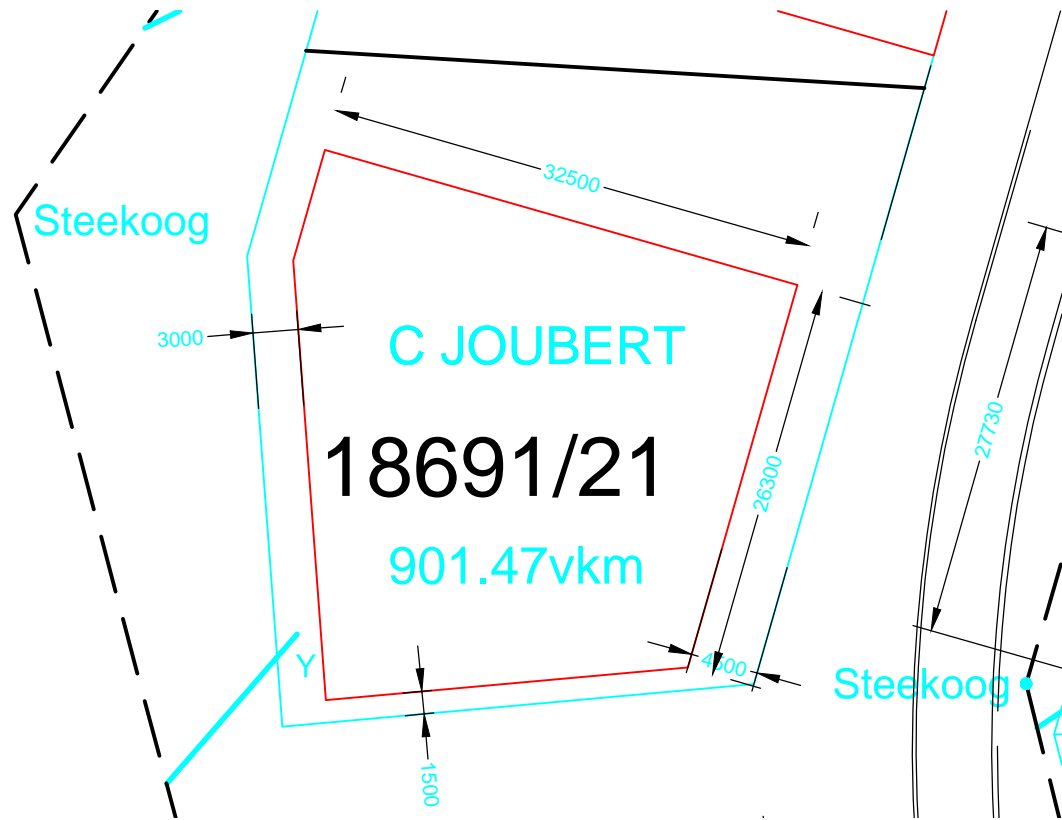

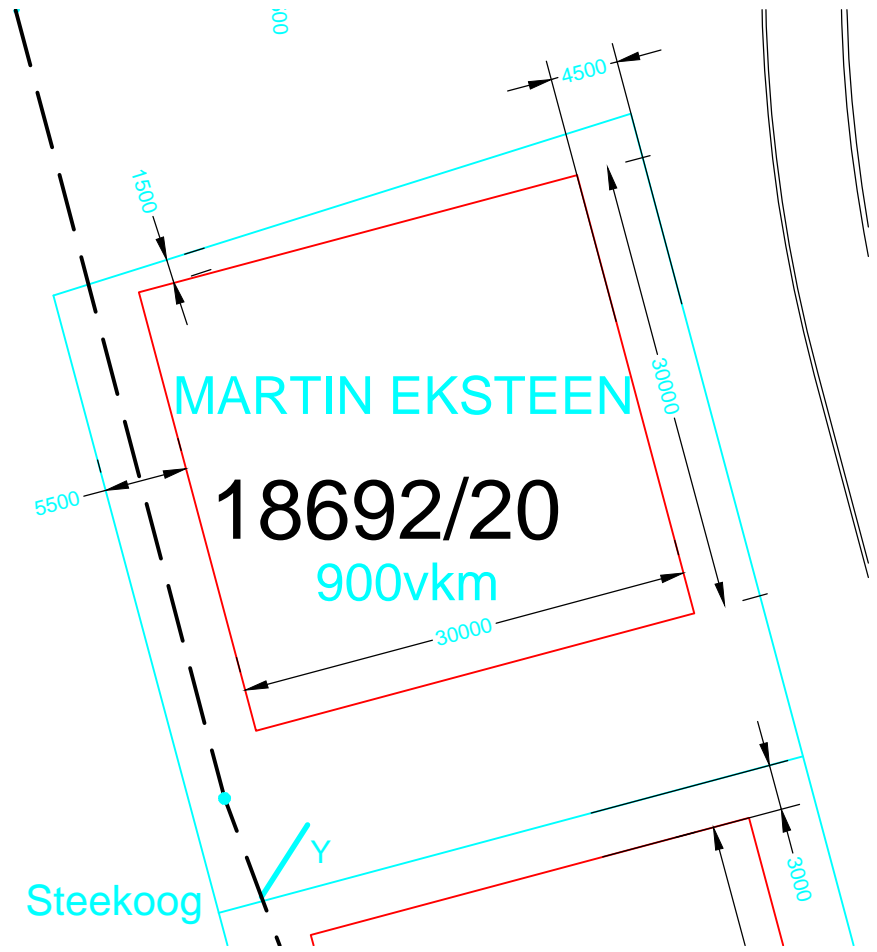



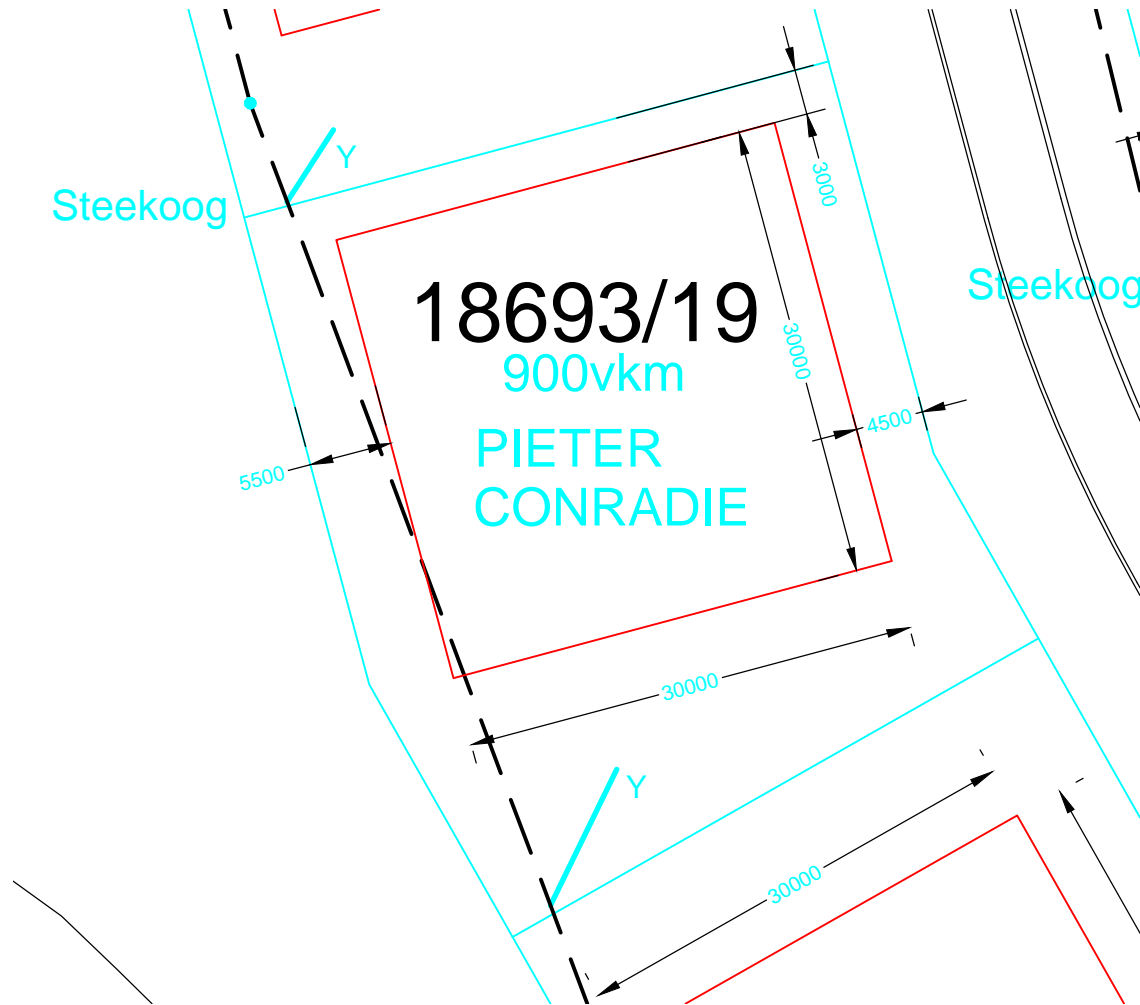

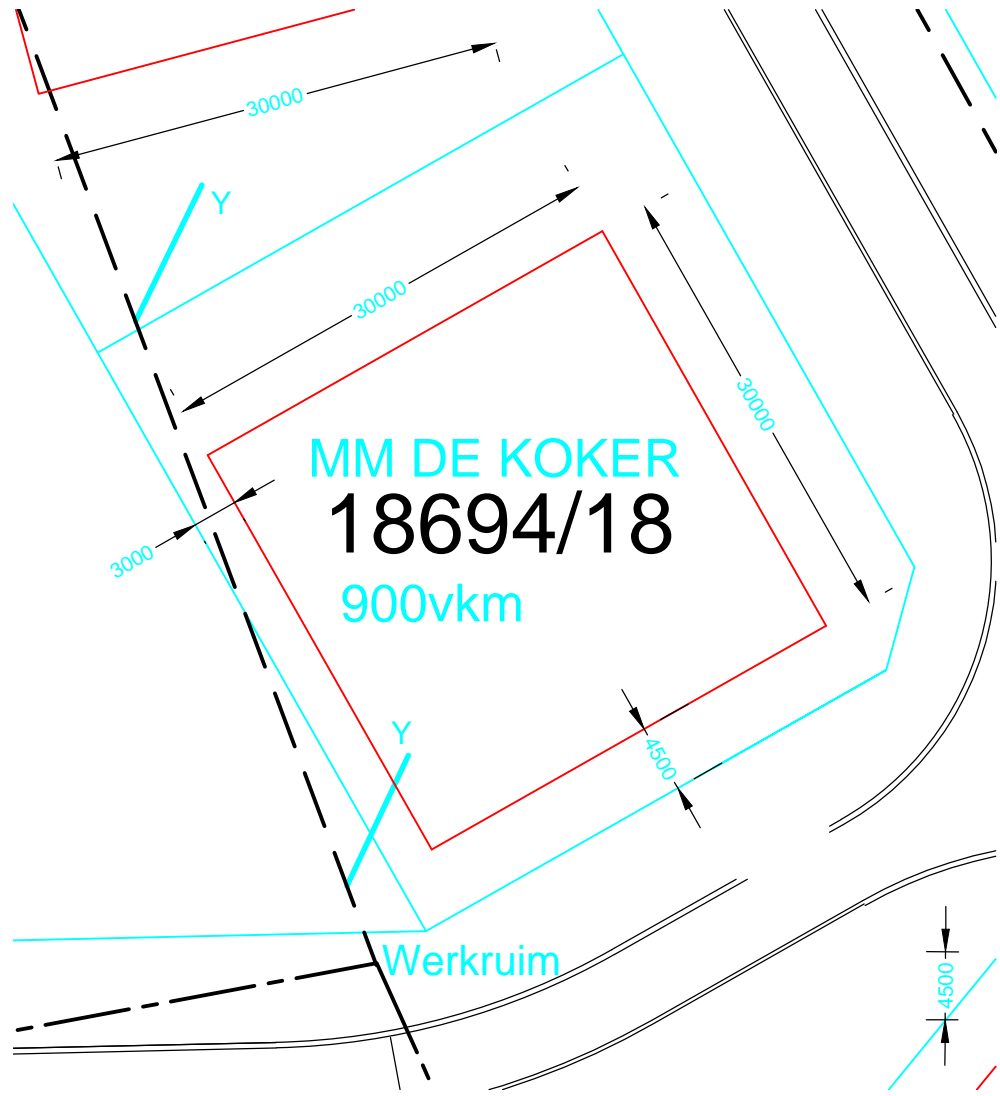

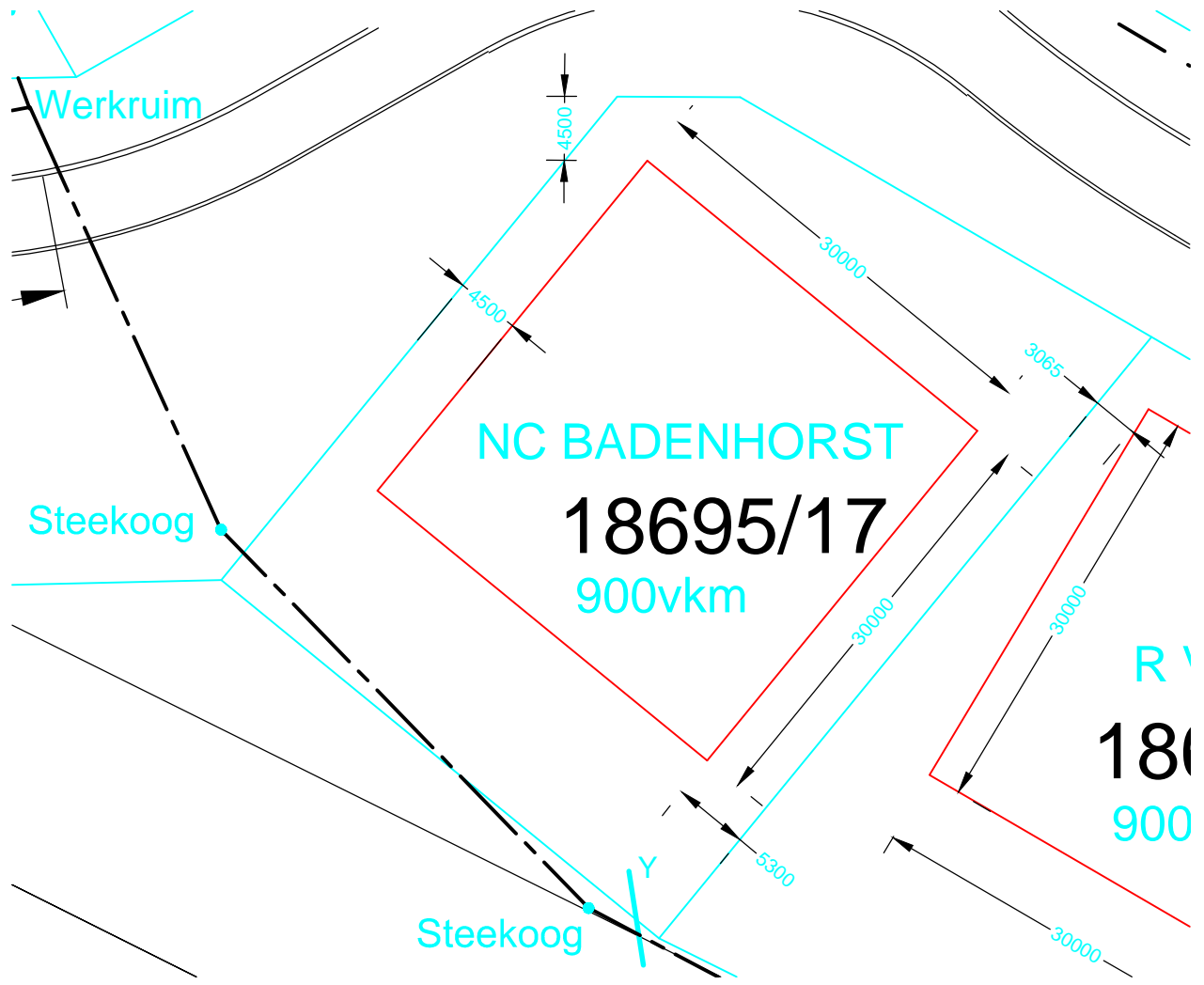

Werkruim

Steekoog

NC BADENHORST

18695/17

900vkm

R

180

900

Steekoog

Y

4500

4500

30000

3065

30000

30000

5300

30000

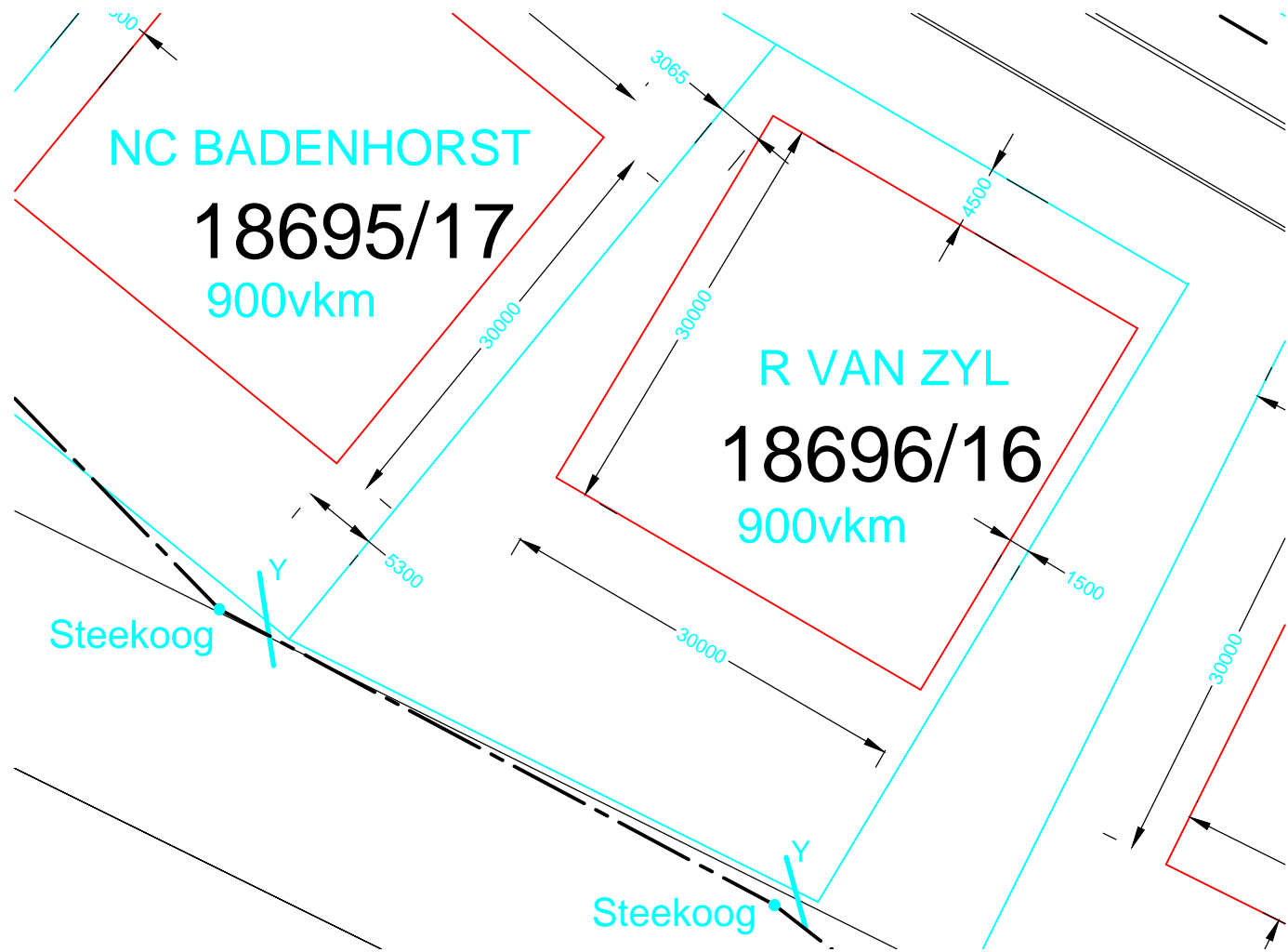

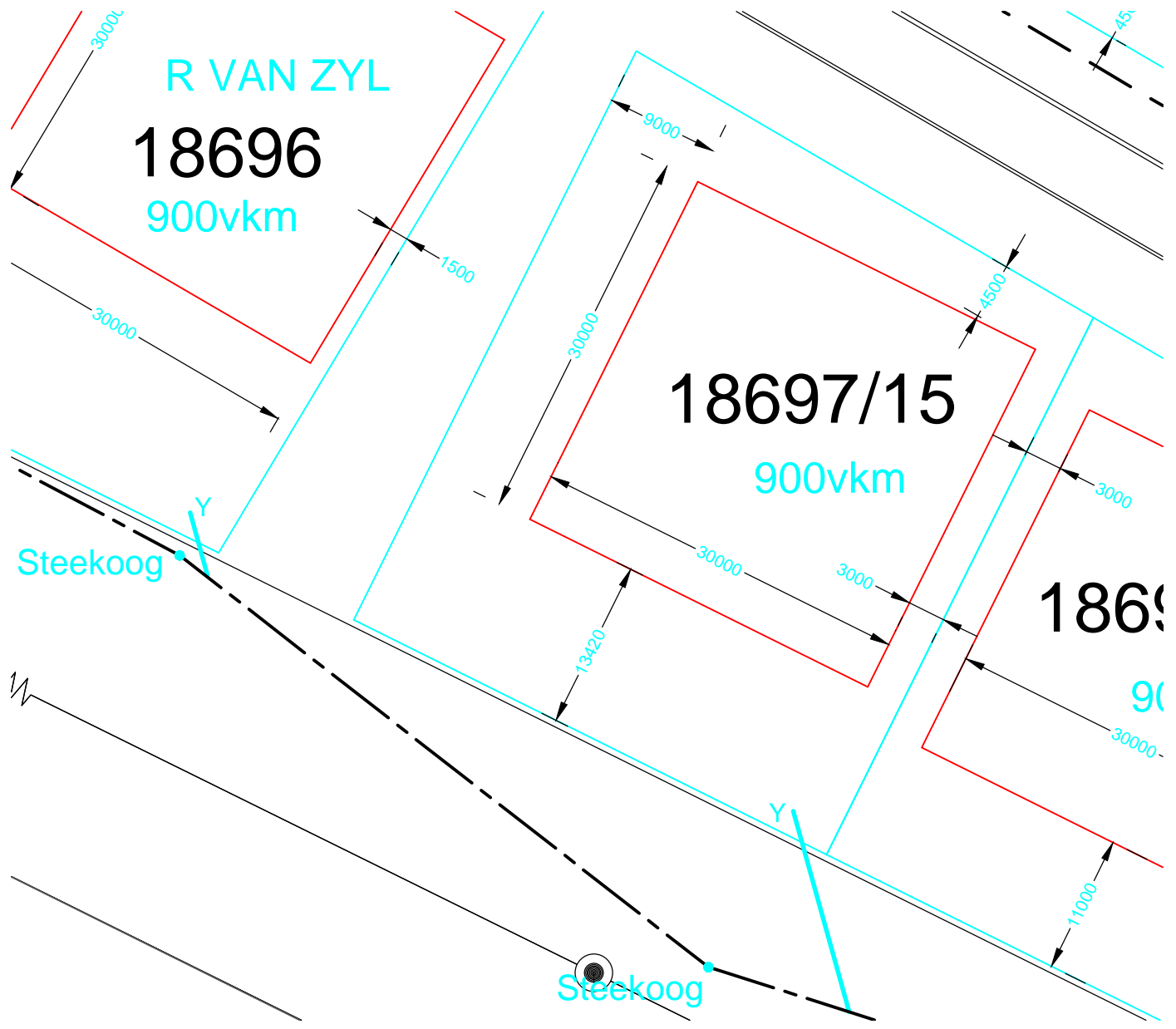

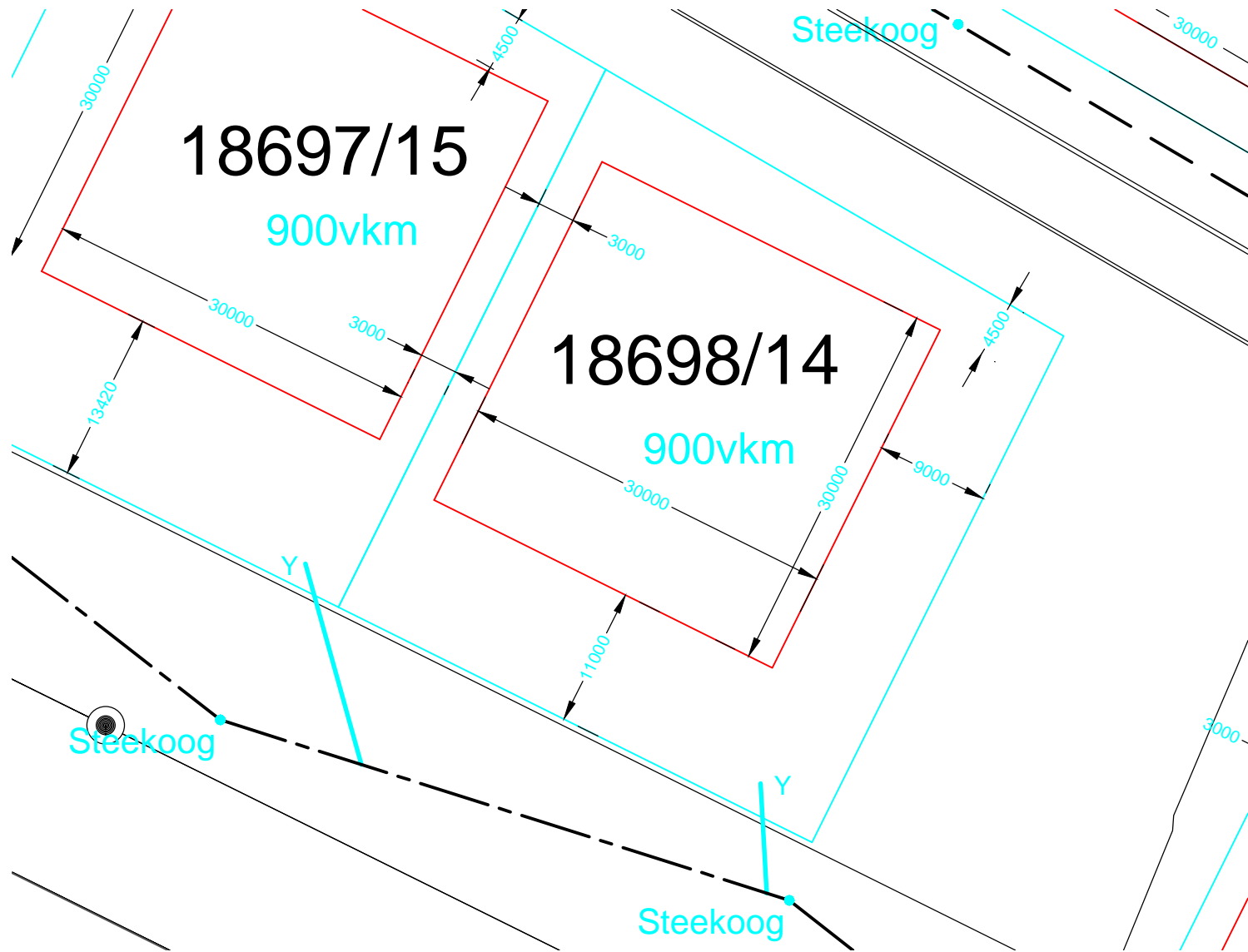



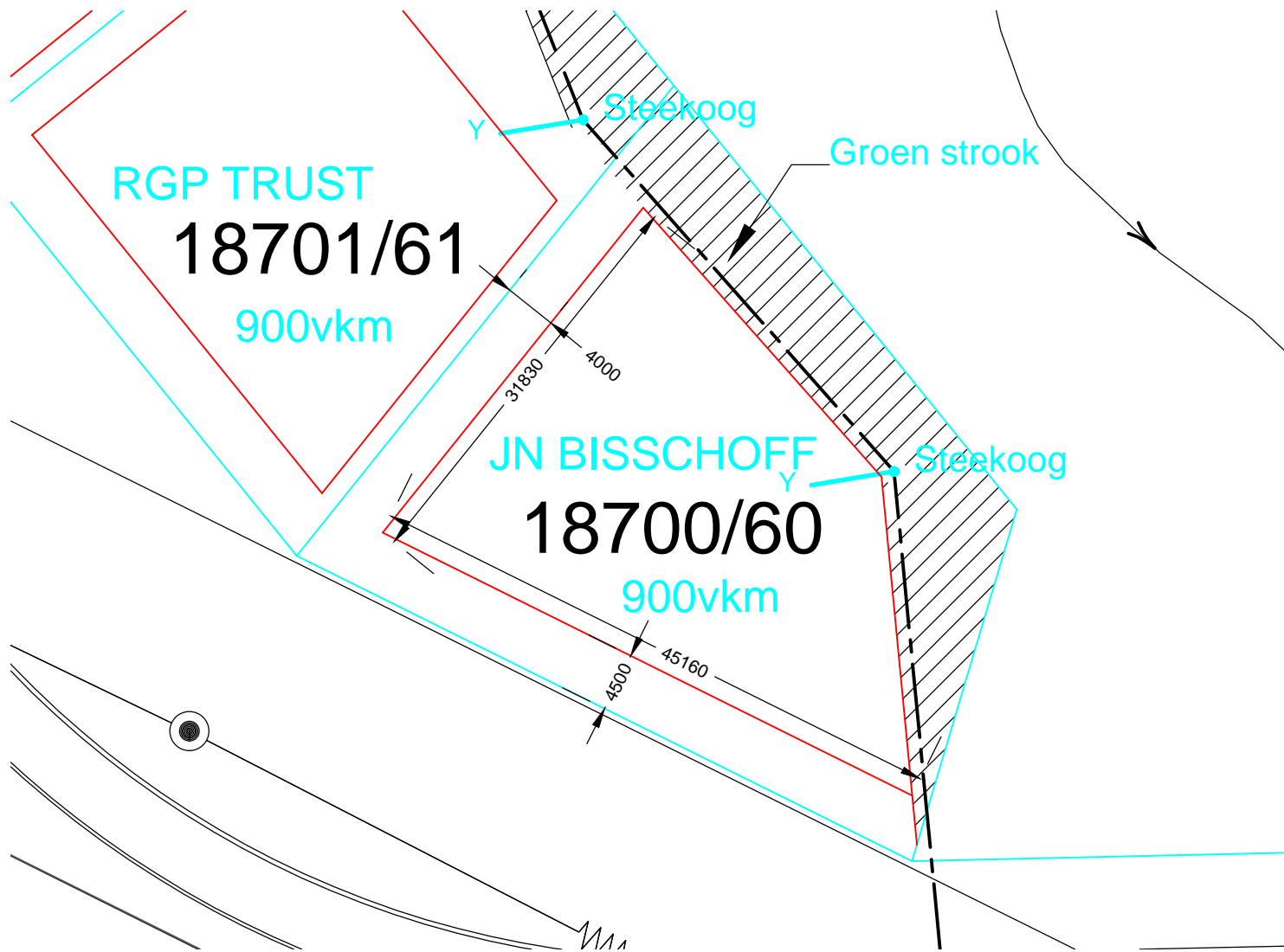



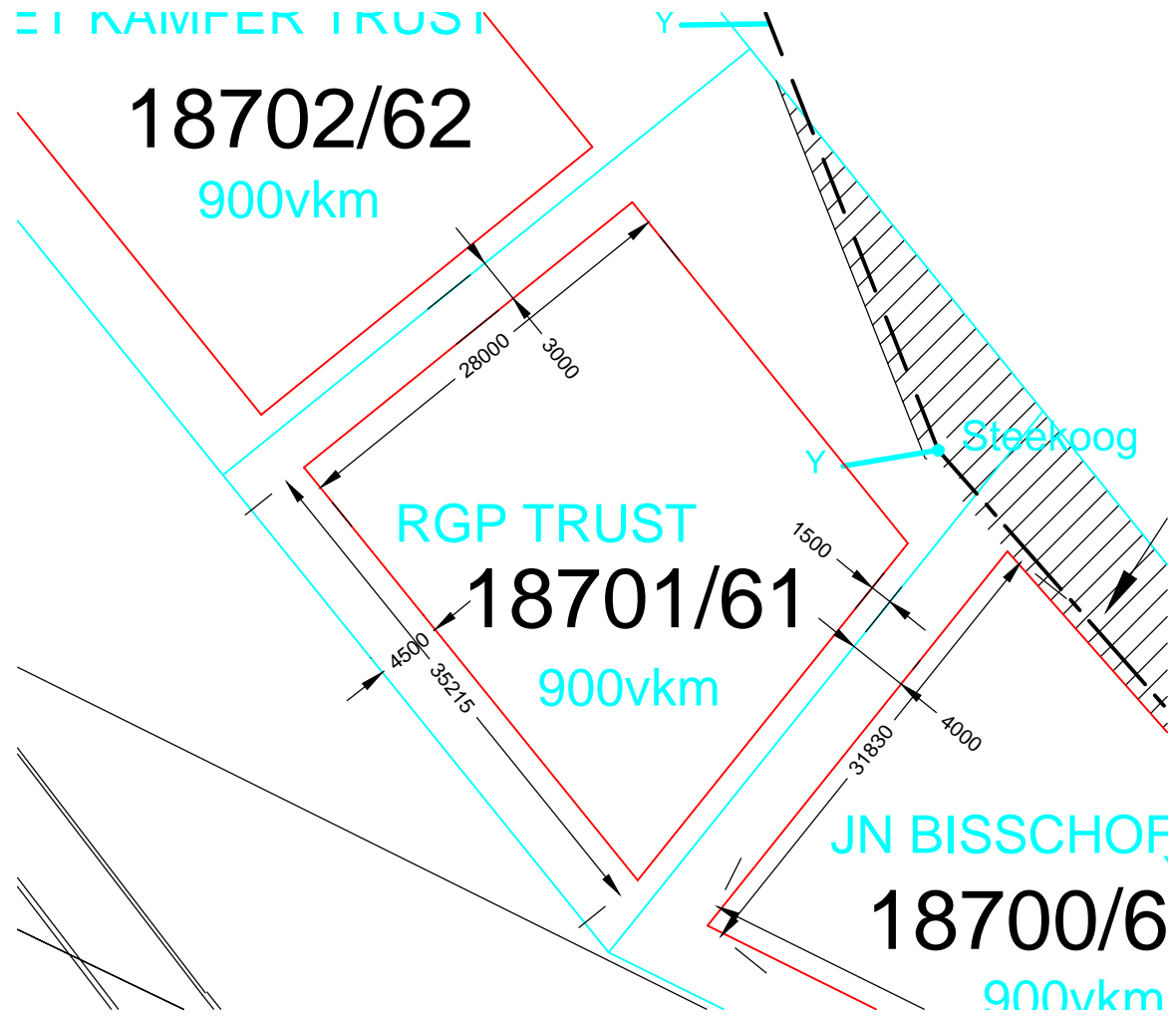

HNSTON  
703/63  
33.15m<sup>2</sup>

PIET KAMFER TRUST  
18702/62  
900vkm

RGP TRUST

Steekoog

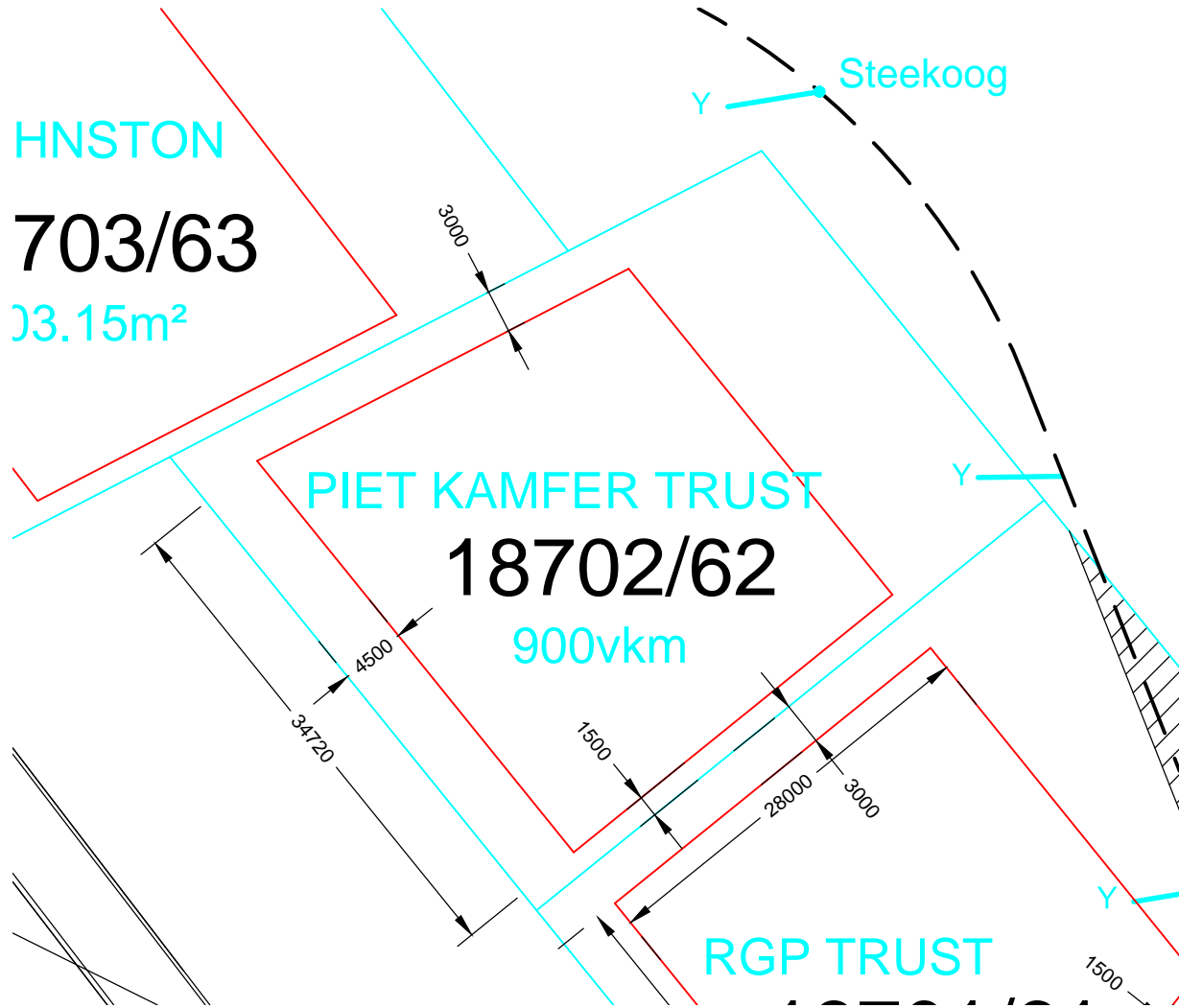

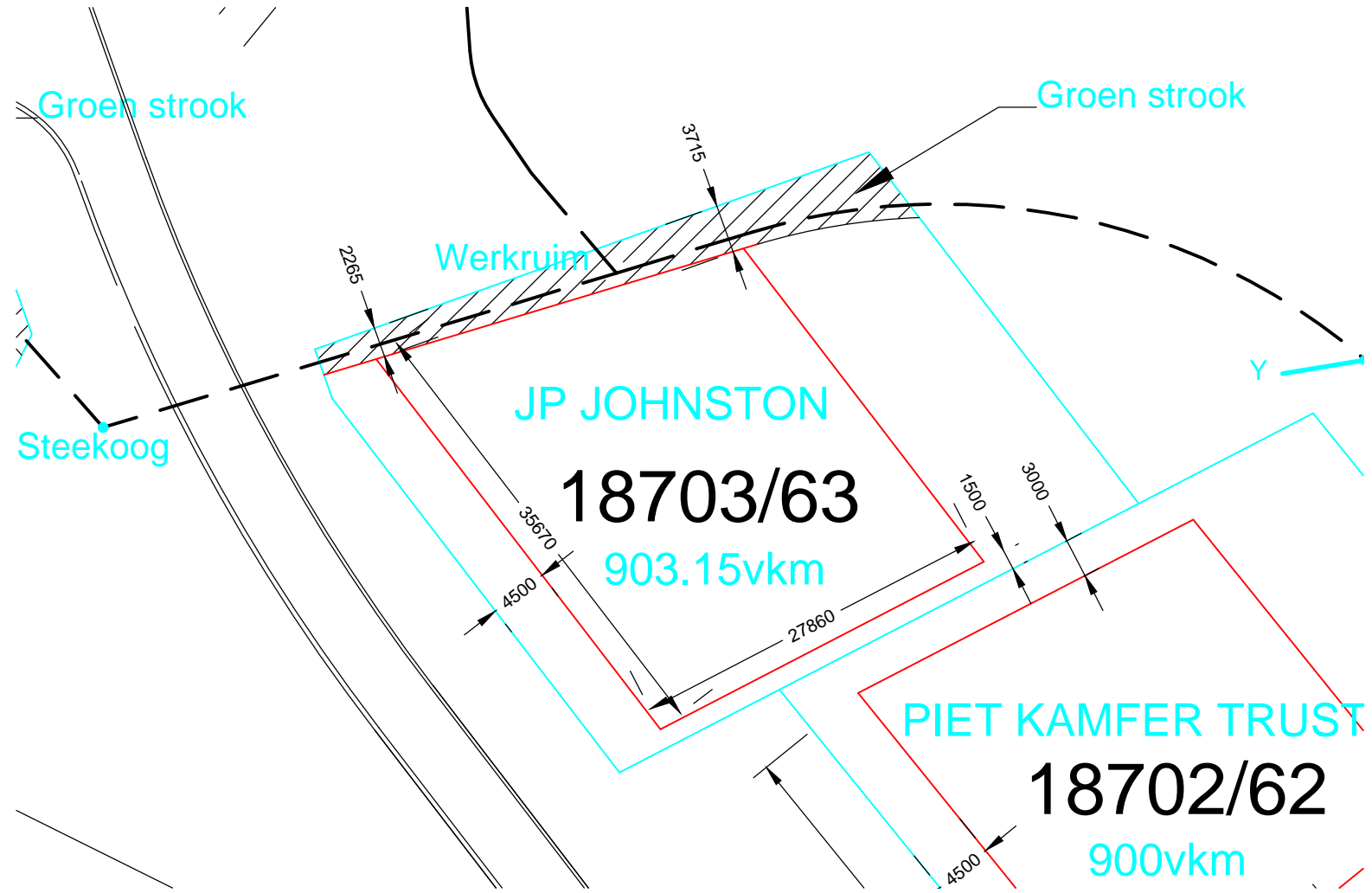

Groen strook

Groen strook

Werkruijn

Steekoog

JP JOHNSTON

18703/63

903.15vkm

PIET KAMFER TRUST

18702/62

900vkm

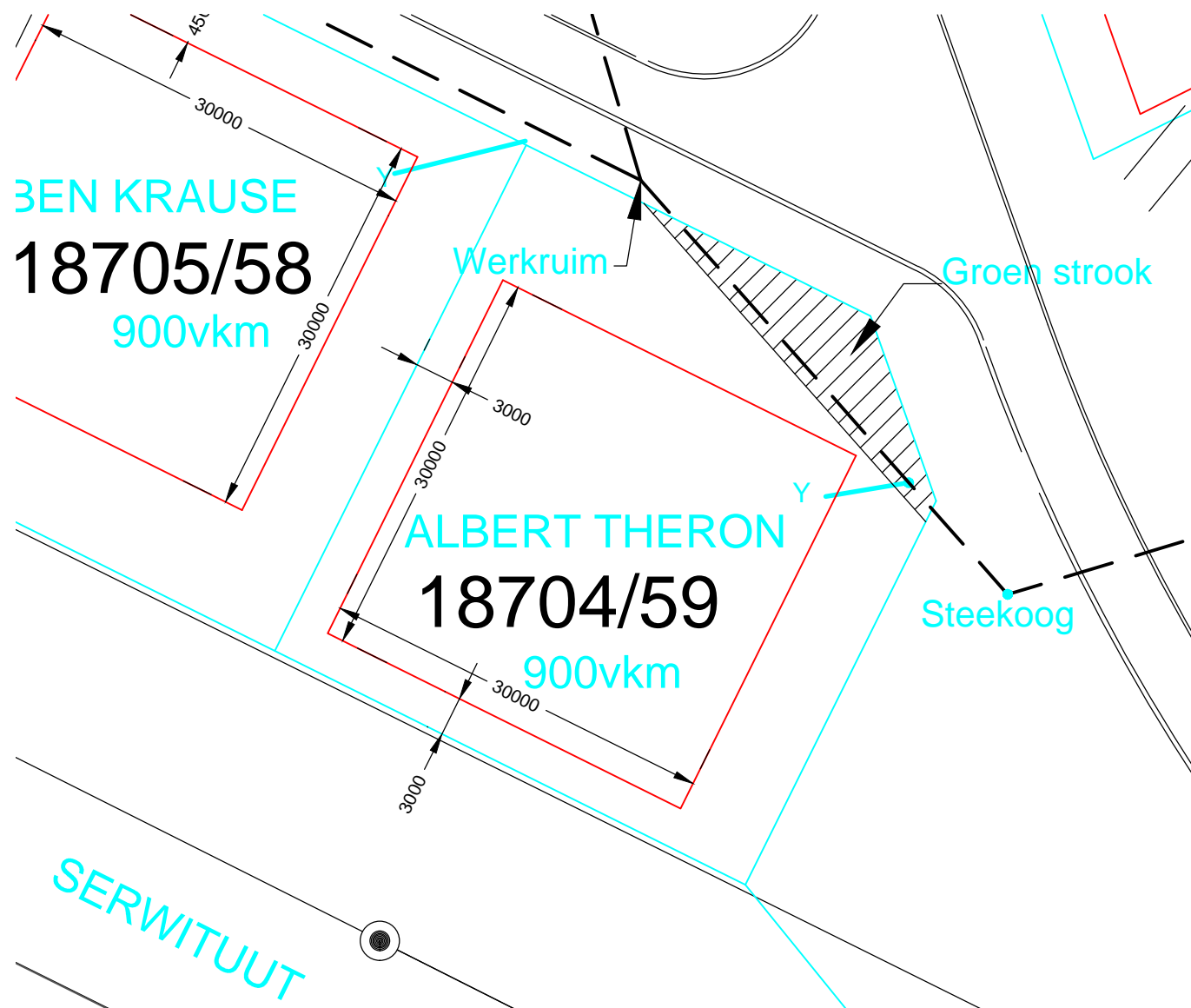

**BEN KRAUSE**  
**18705/58**  
900vkm

**ALBERT THERON**  
**18704/59**  
900vkm

Werkruiim

Groen strook

Steekoog

SERWITUUT

Y

Y

30000

450

30000

3000

30000

3000

30000

3000





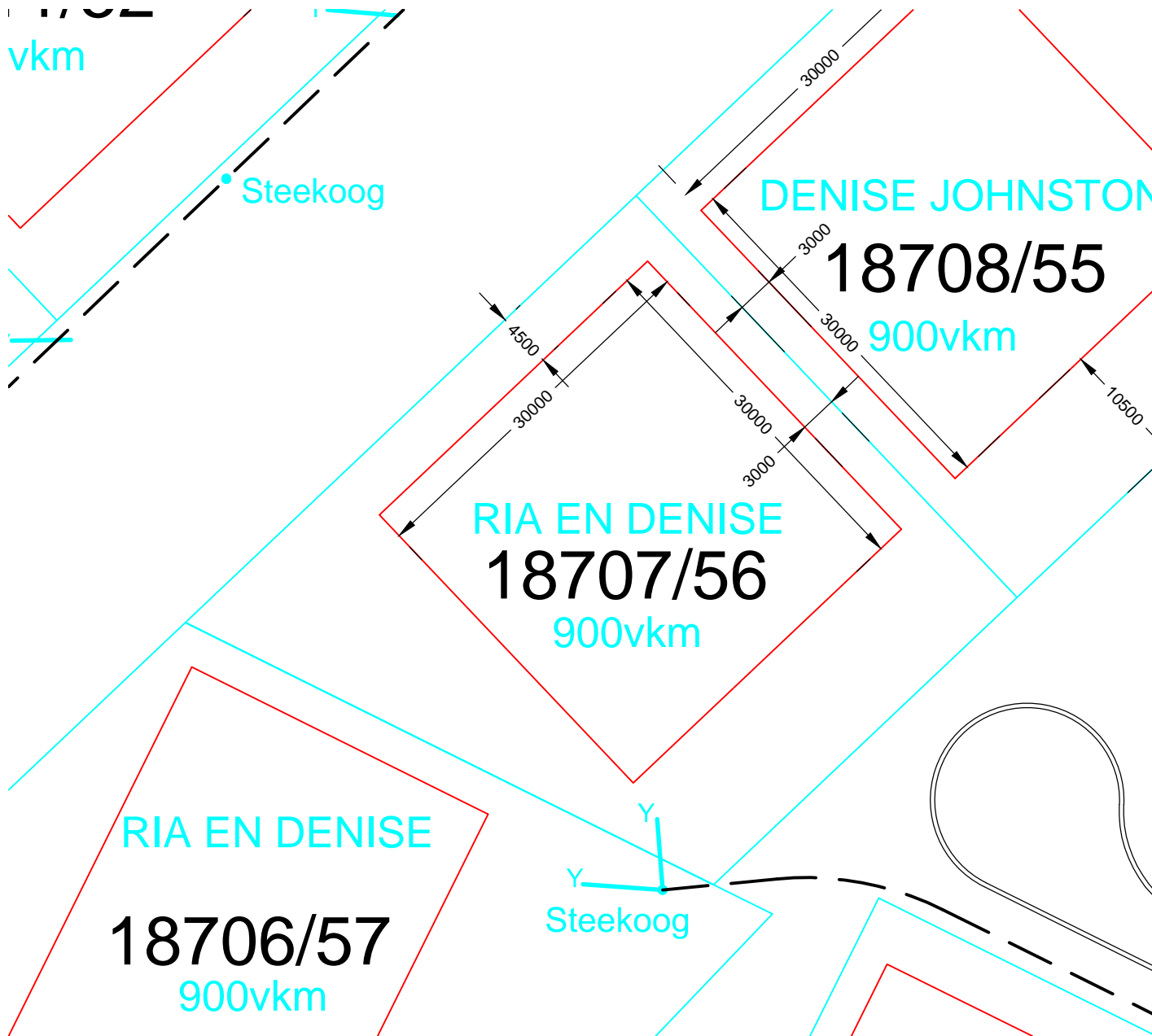

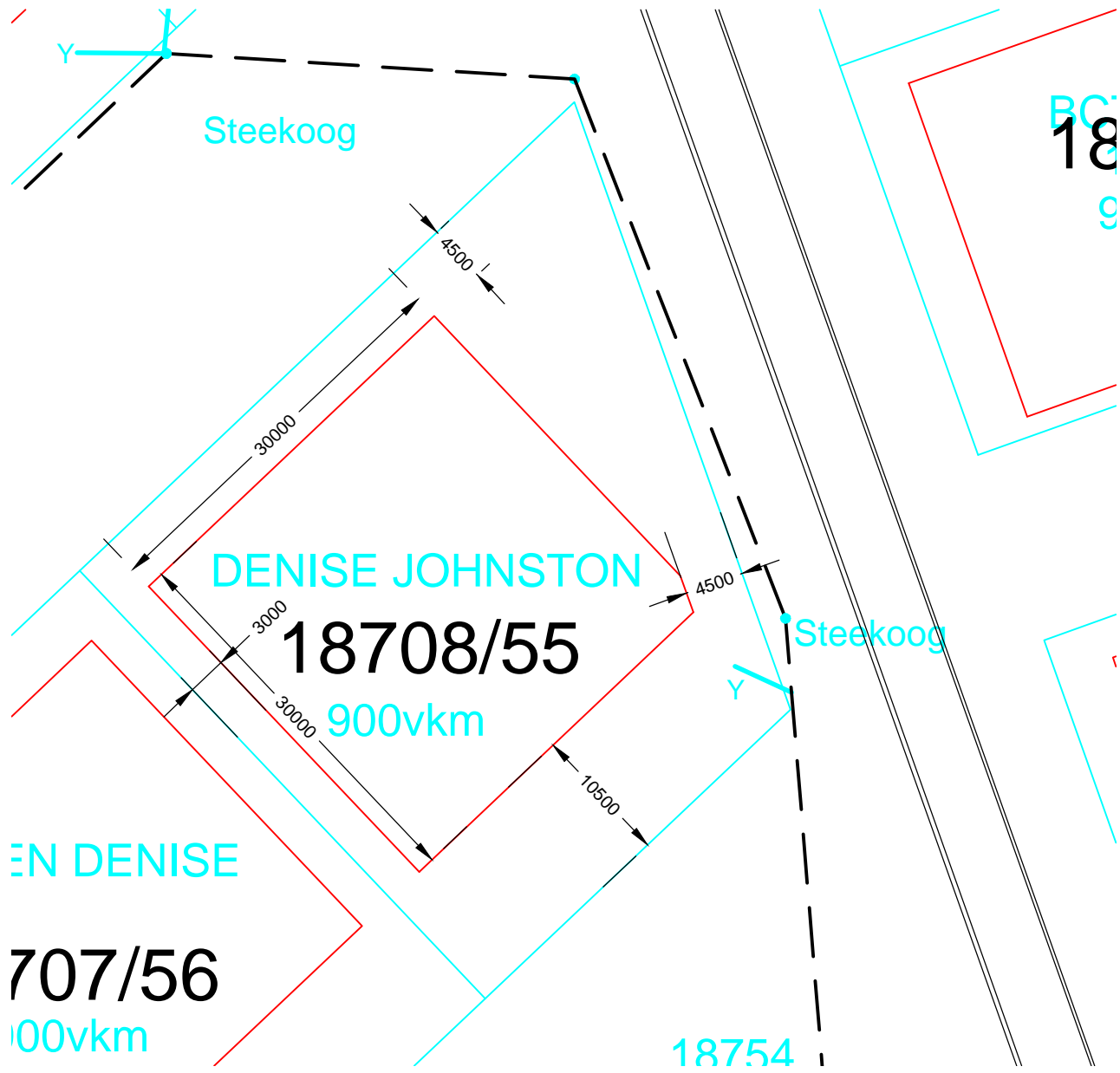

Steekoog

DENISE JOHNSTON

18708/55

900vkm

EN DENISE

707/56

100vkm

18754

BC  
18  
9

Steekoog



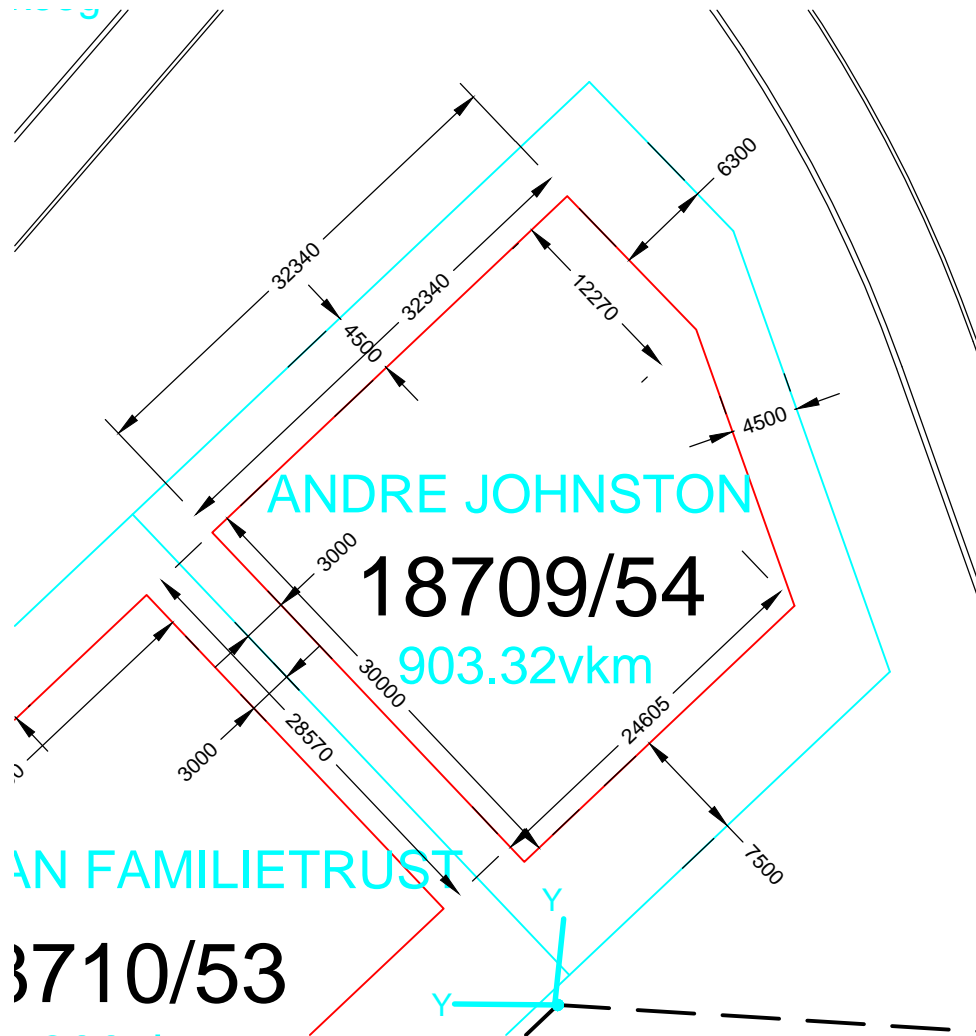

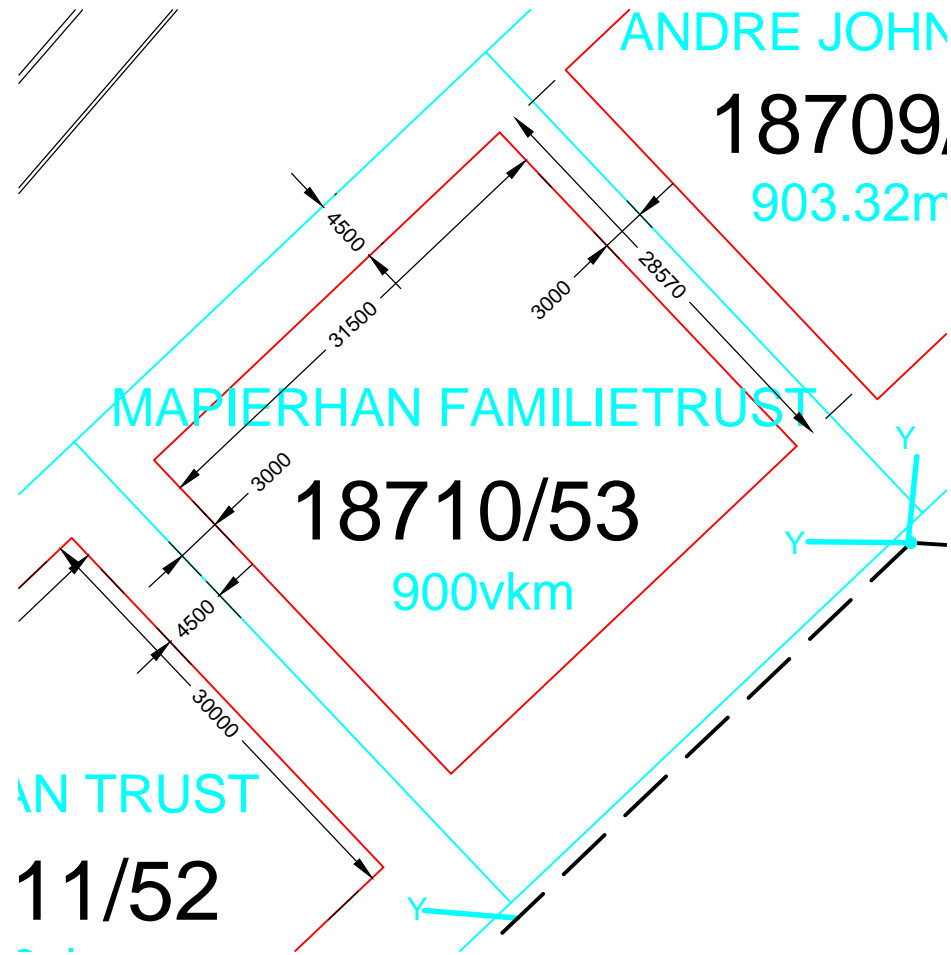

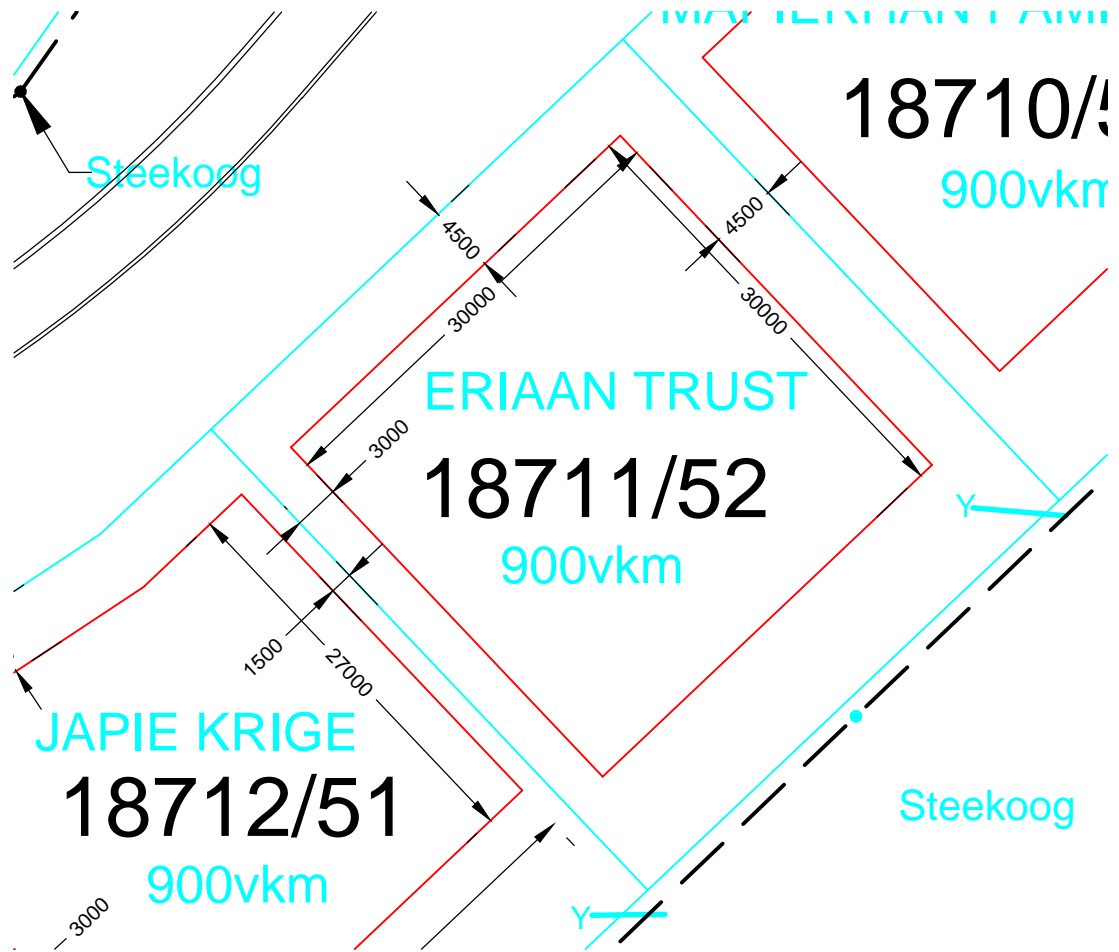

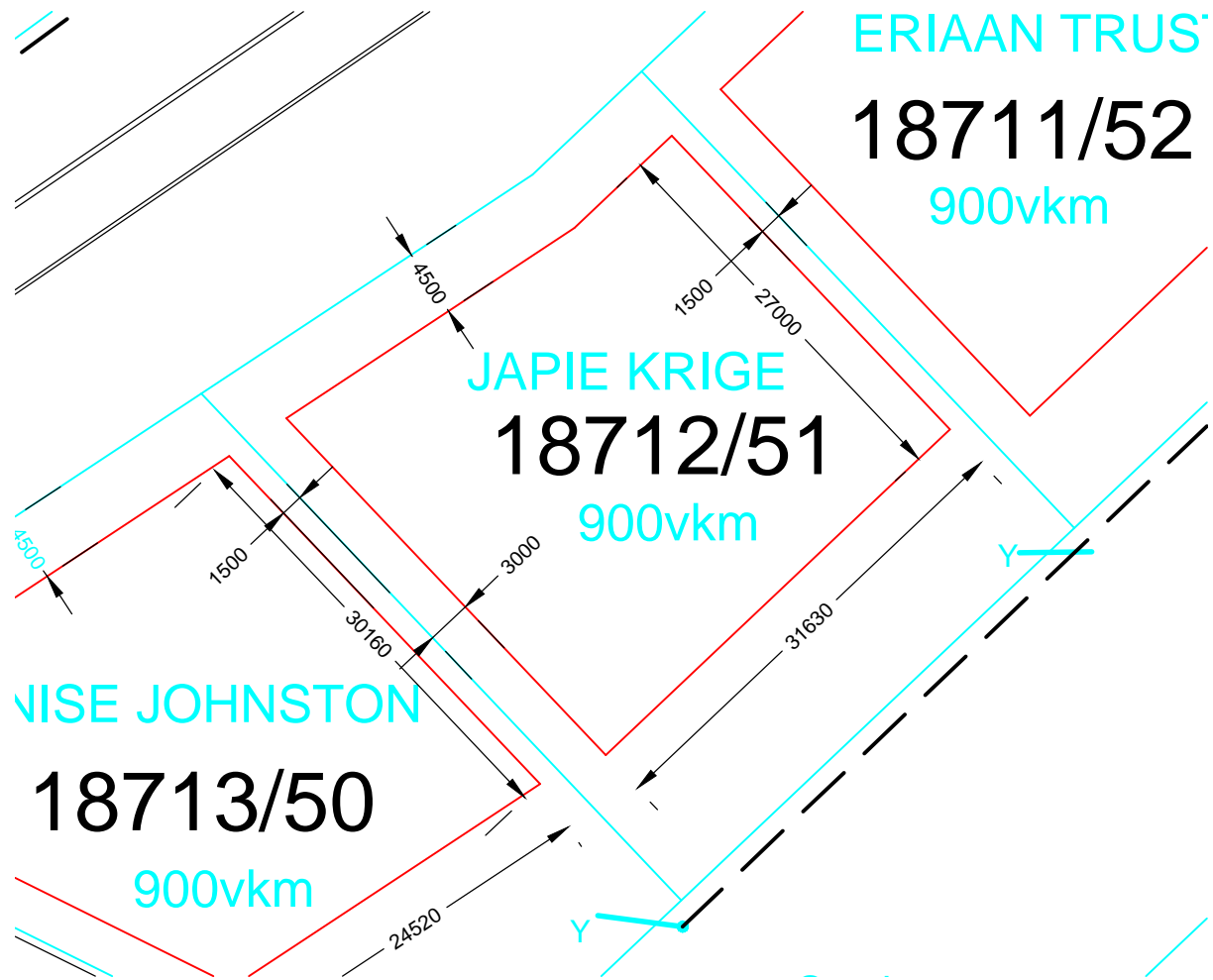

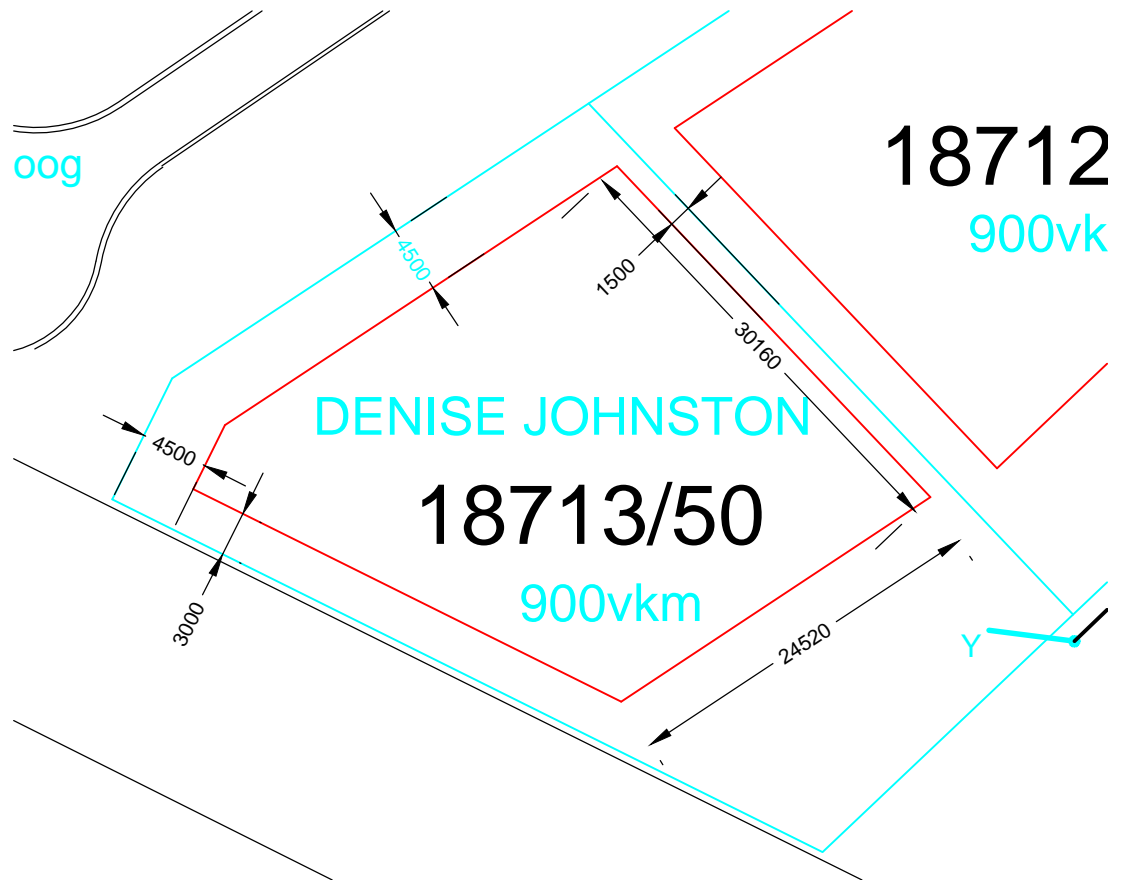

DEJARO TRUST & AMSTON TRUST  
ANDRE EN FRANCOISE

18715/48

900vkm

18714/49

901.03VKM

Steekoog

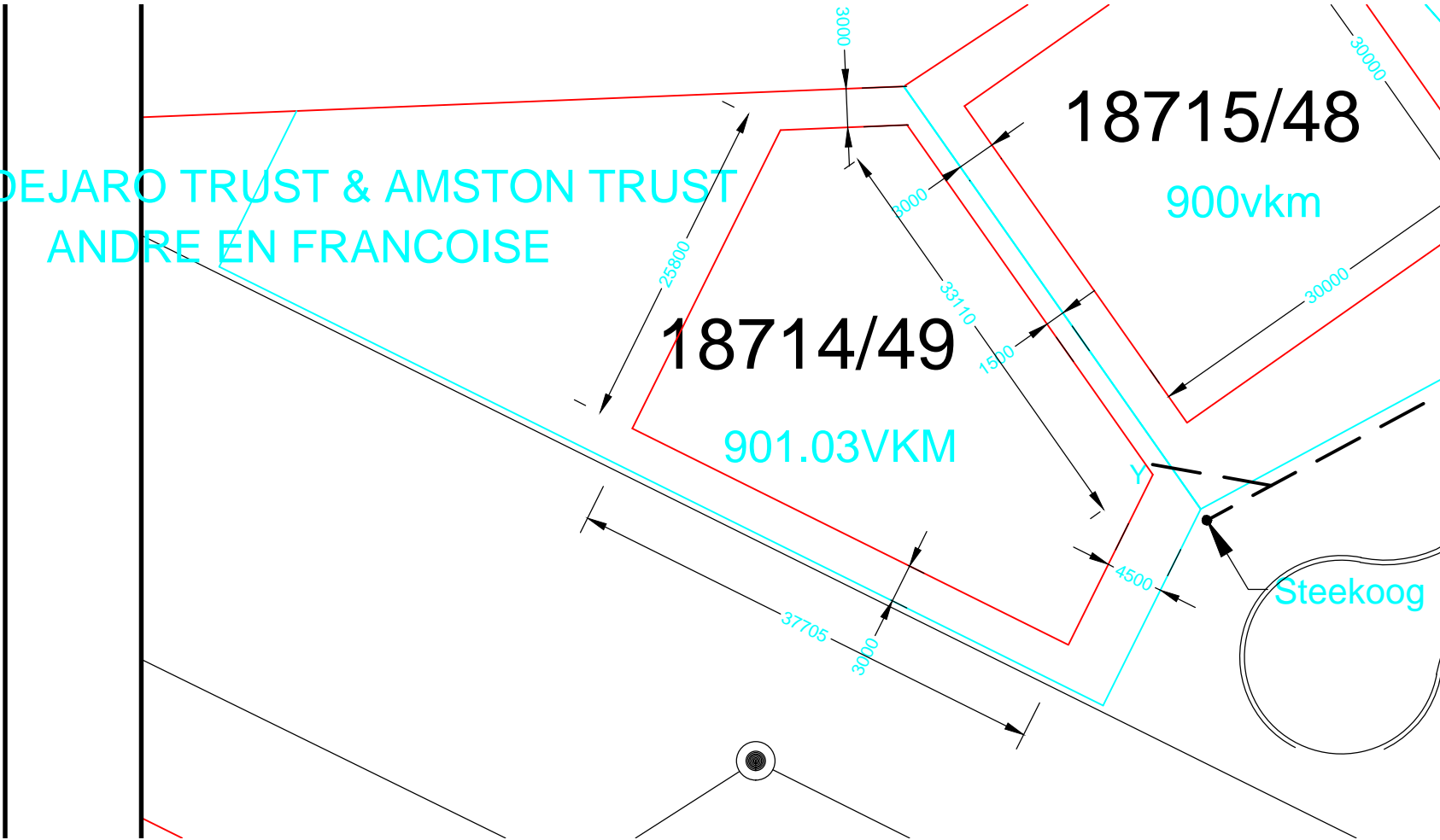



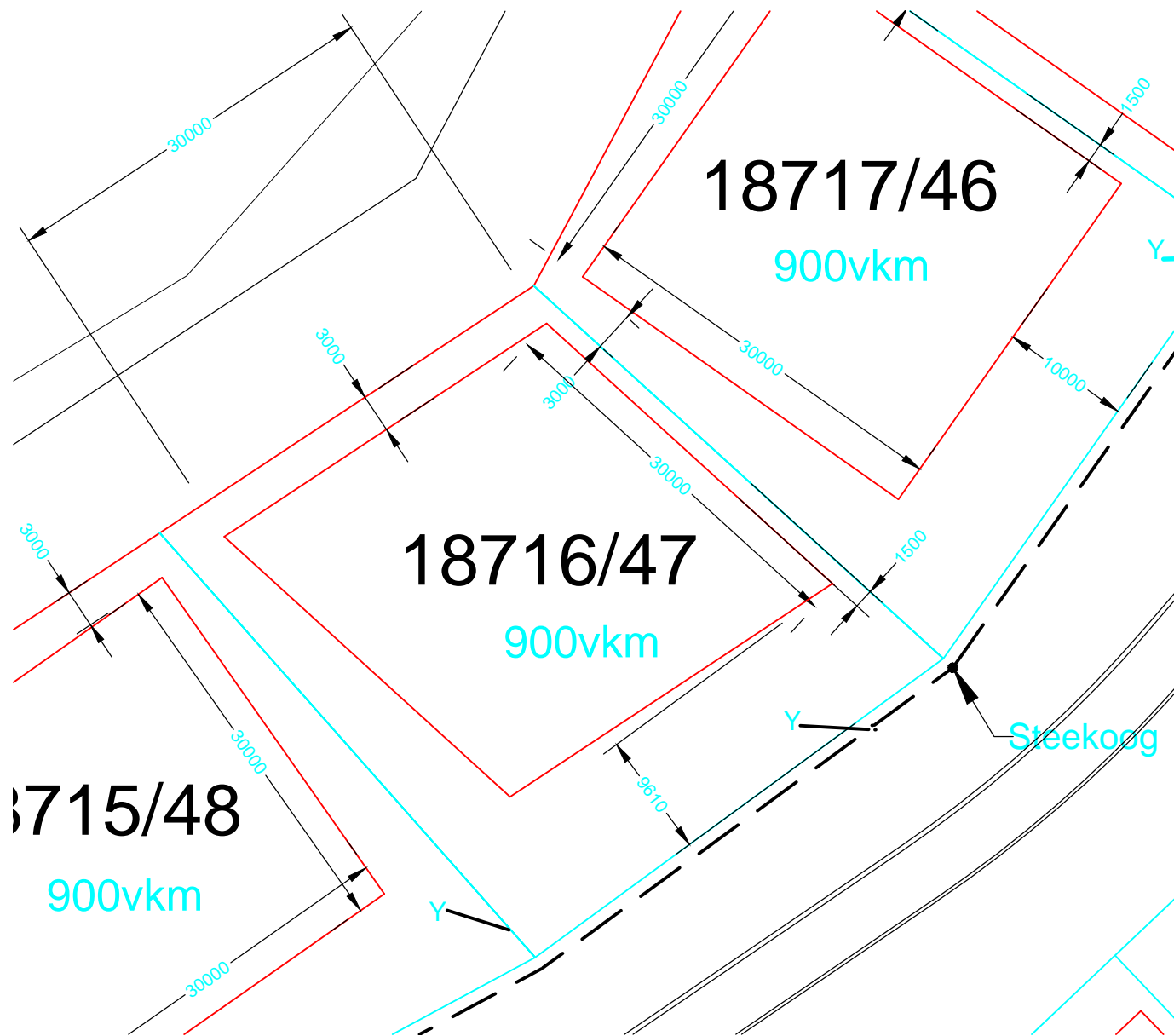



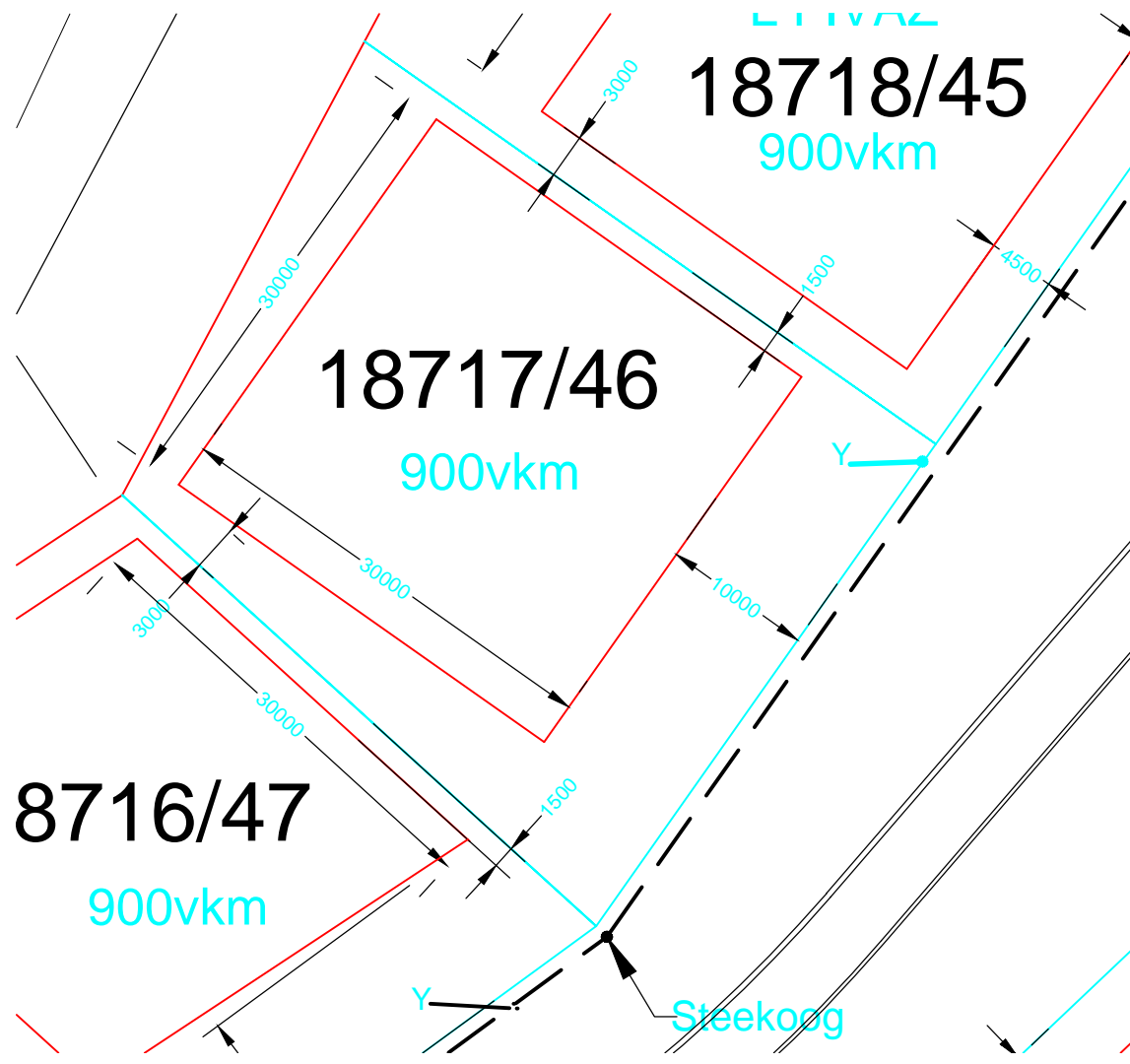

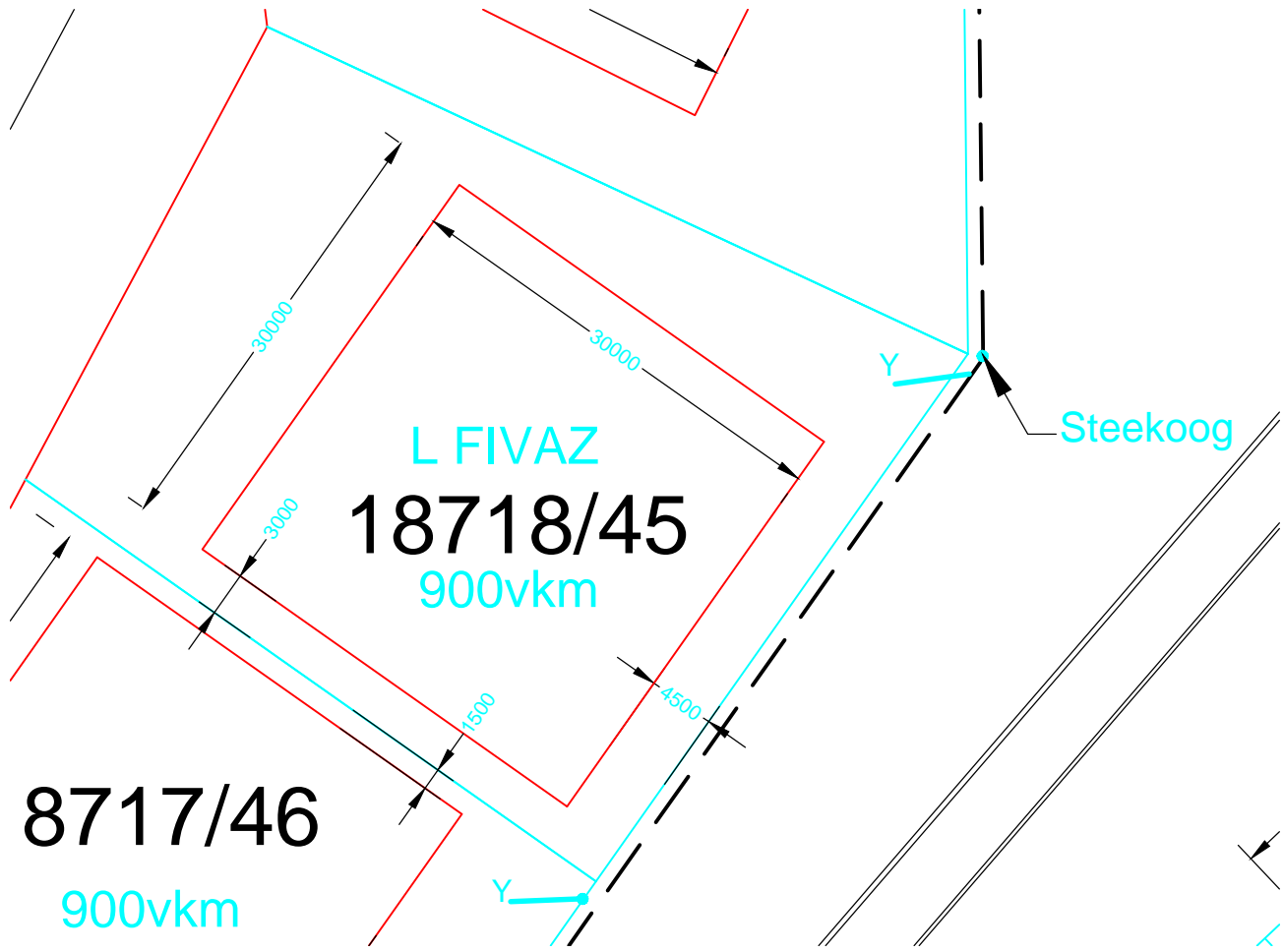



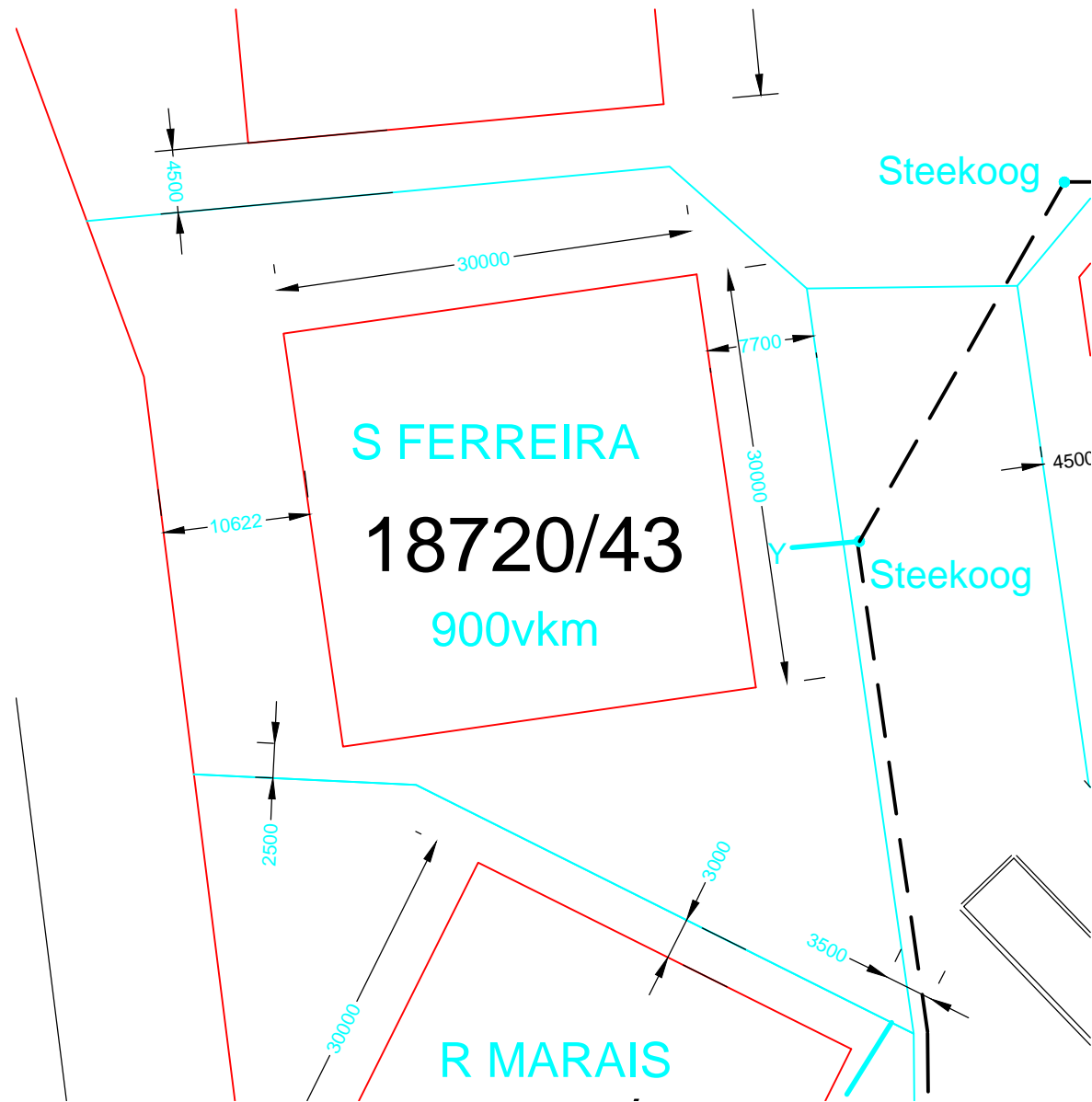

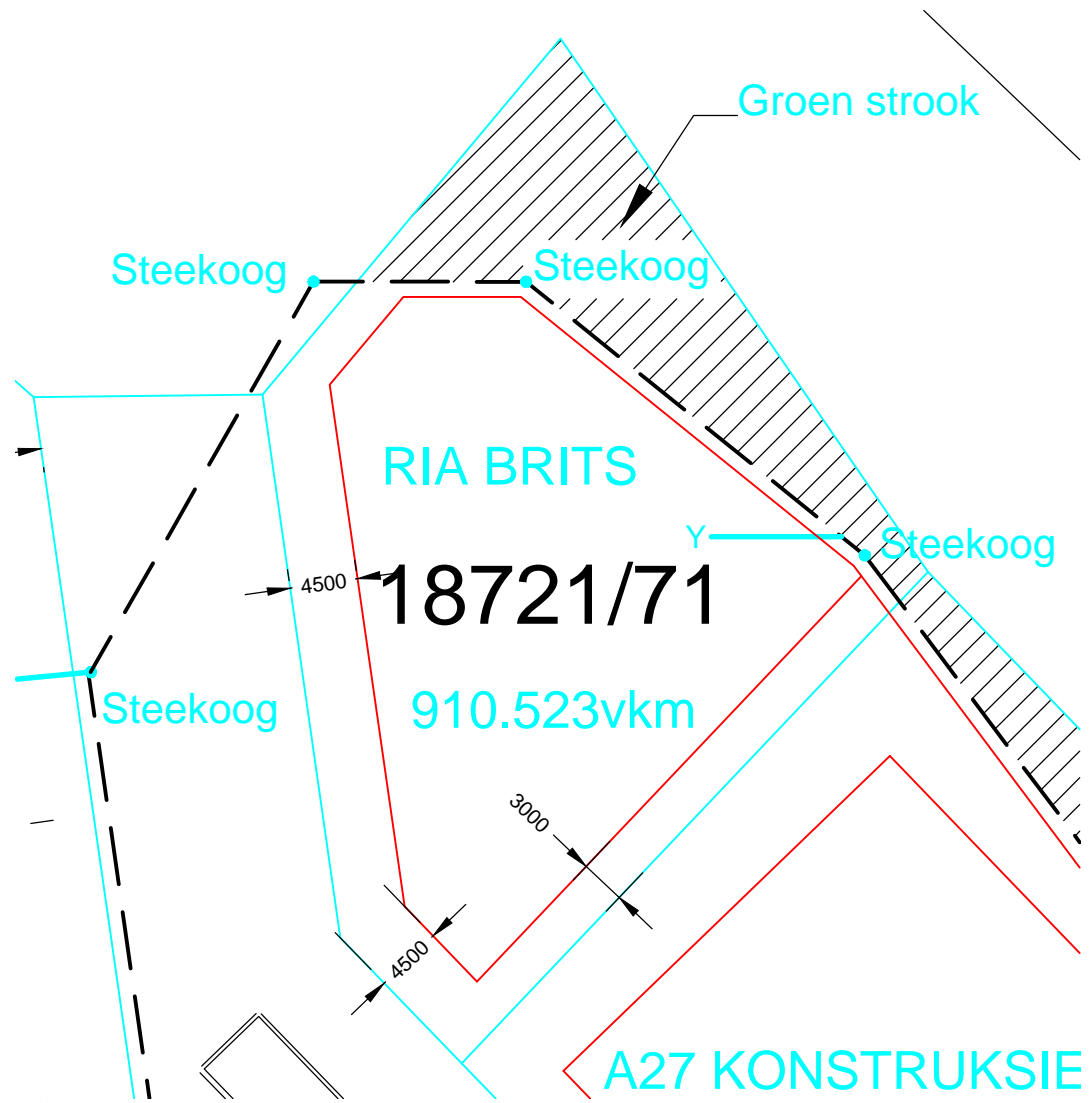

18721/71

910.523vkm

A27 KONSTRUKSIE

18722/70

900vkm

DU PLESSIS  
LLAMA TRUST

Groen strook

Steeko

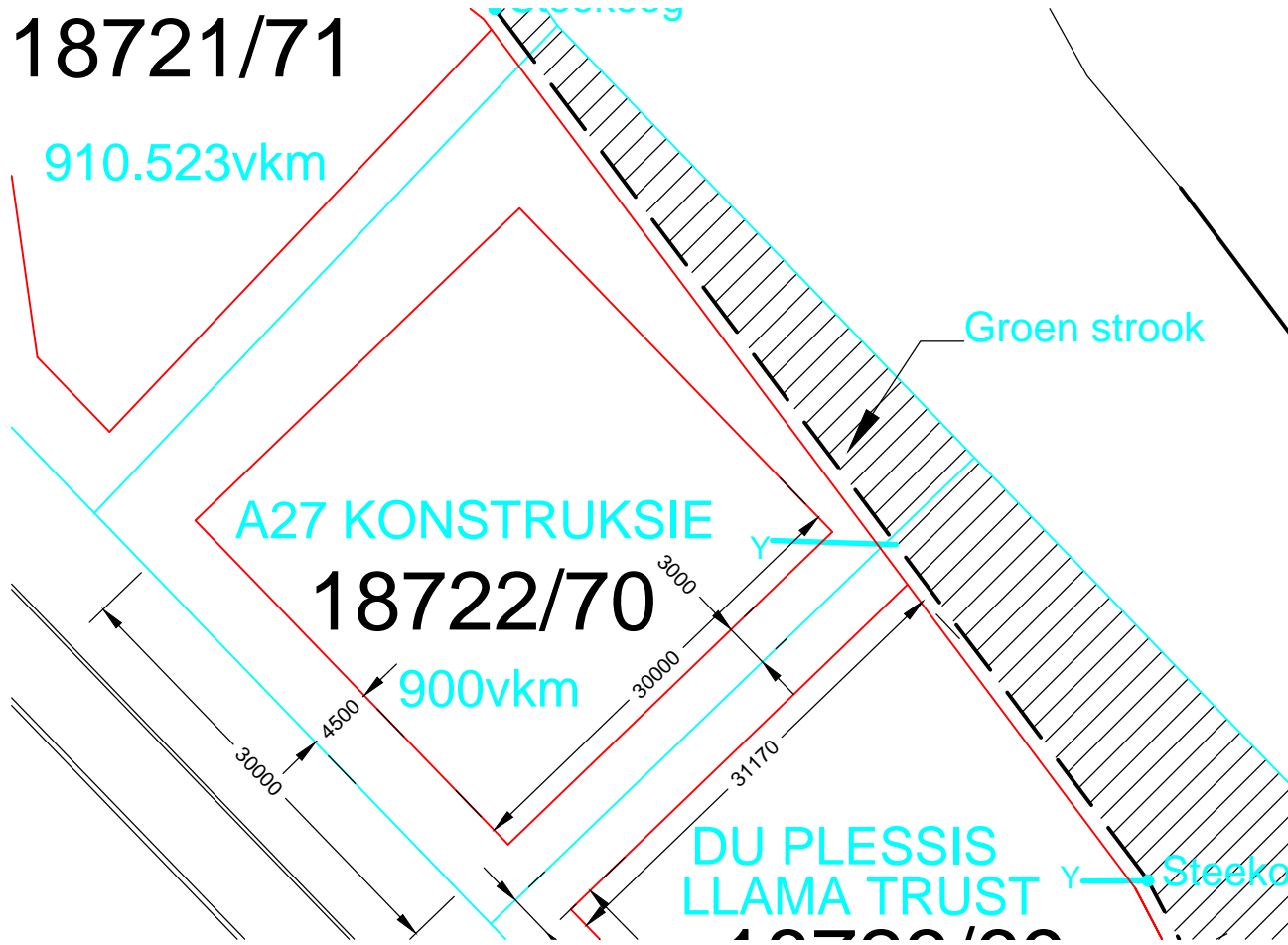

INSTRUKSIE  
722/70  
900vkm

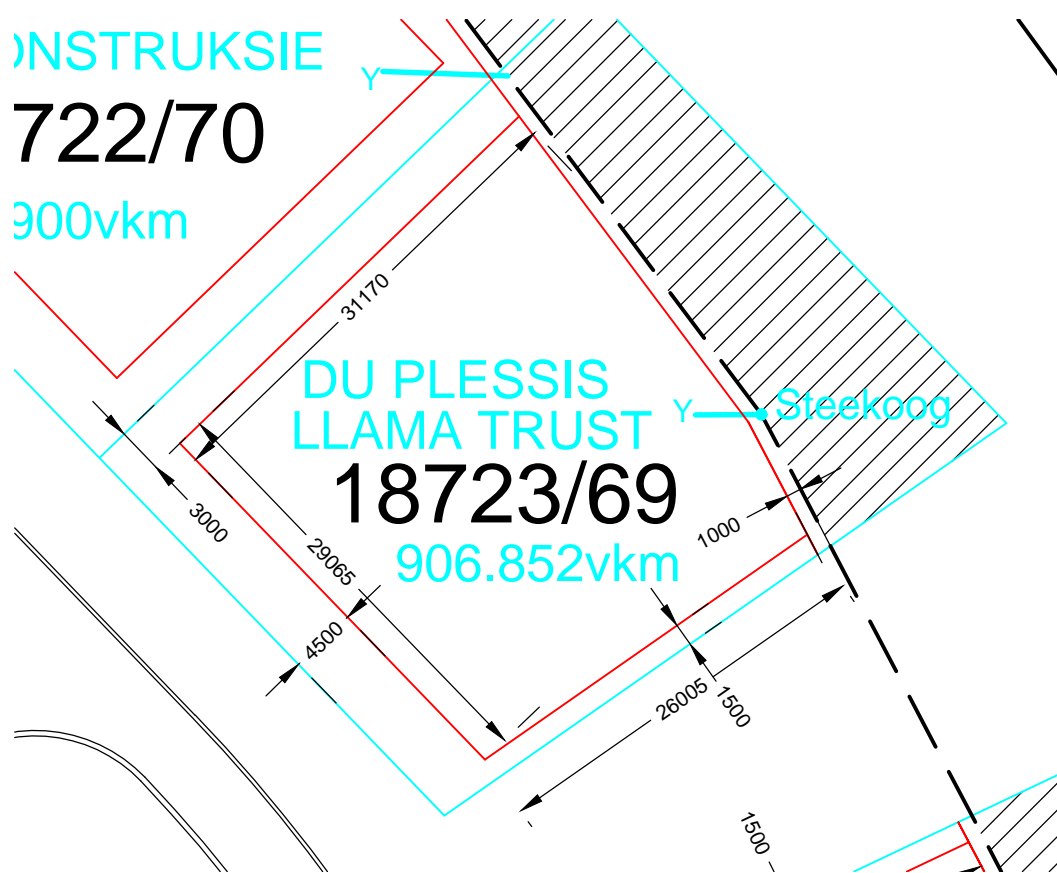

DU PLESSIS  
LLAMA TRUST  
18723/69  
906.852vkm

Steekhoog

31170

3000

29065

4500

1000

26005

1500

1500

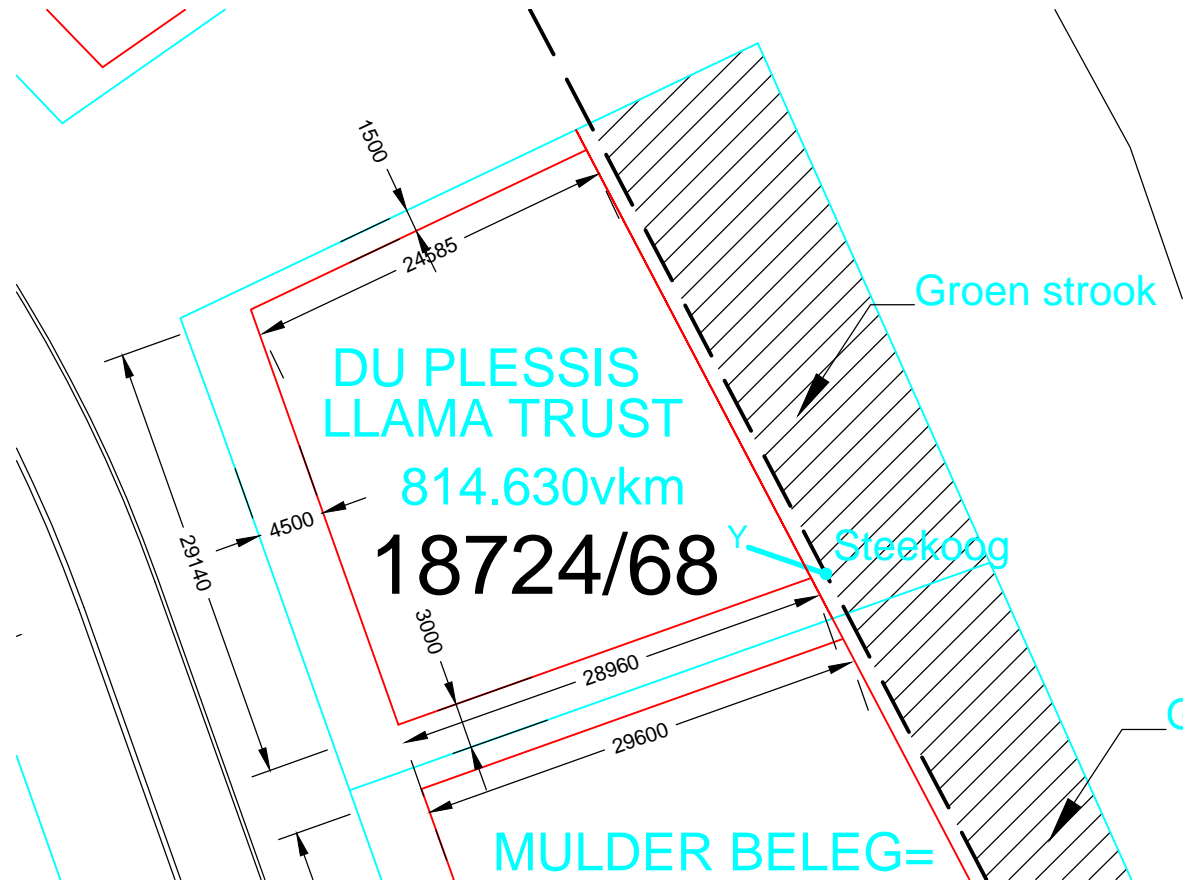



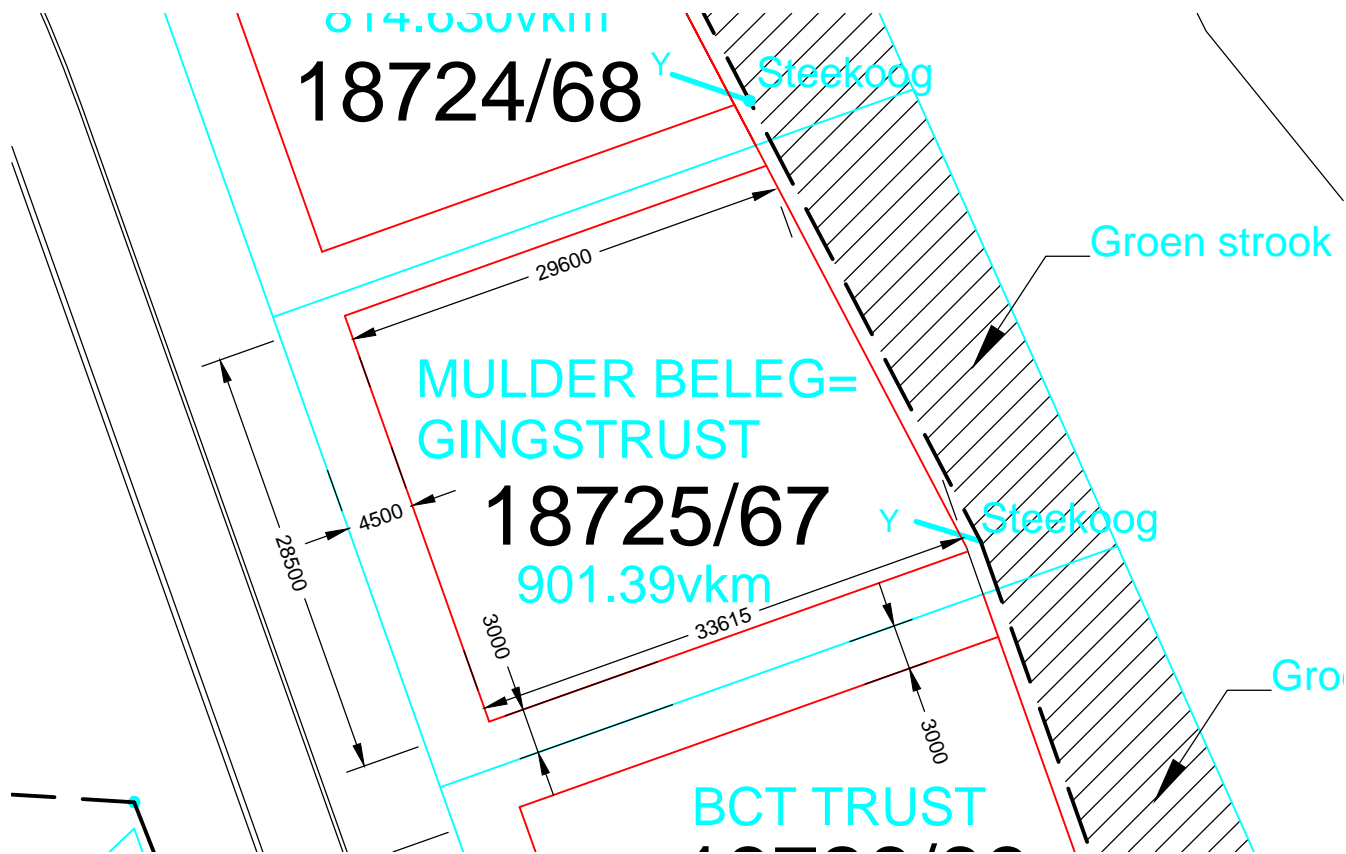

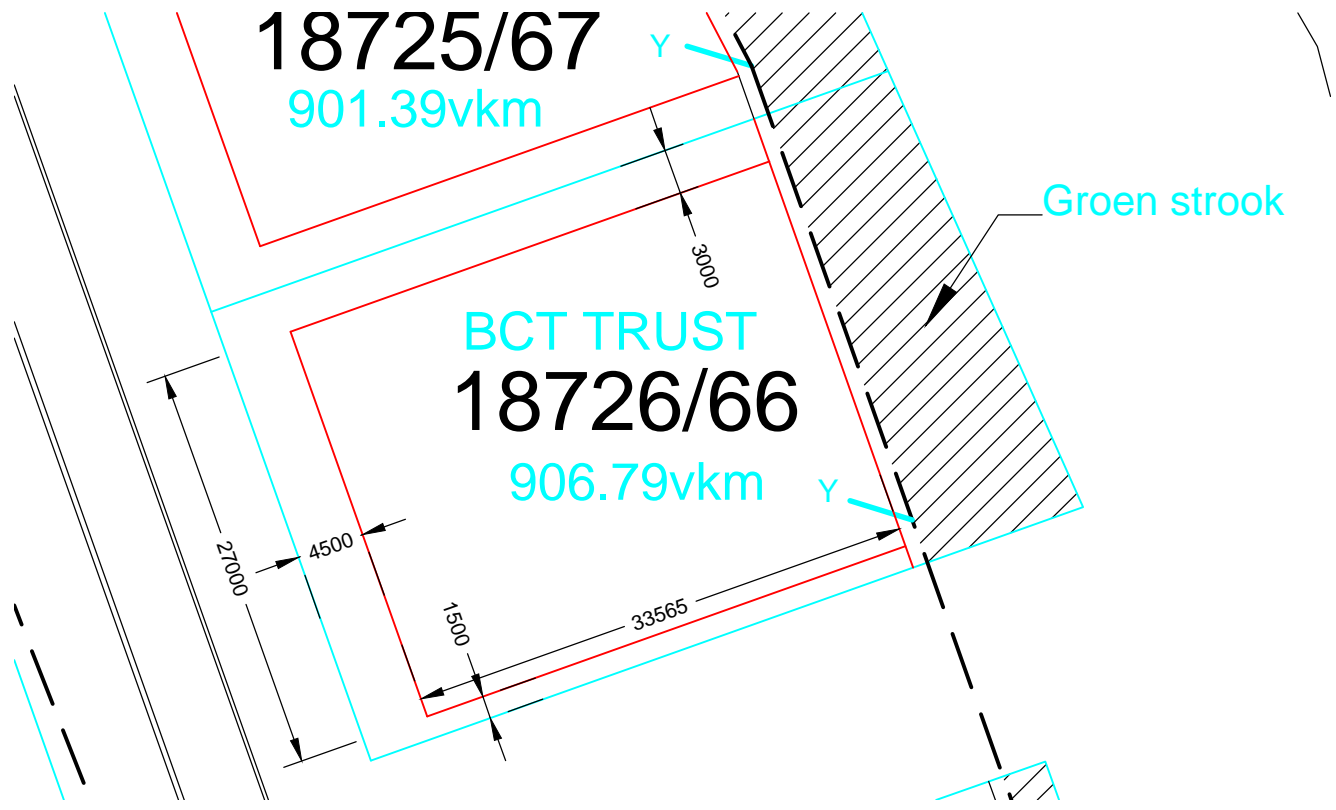

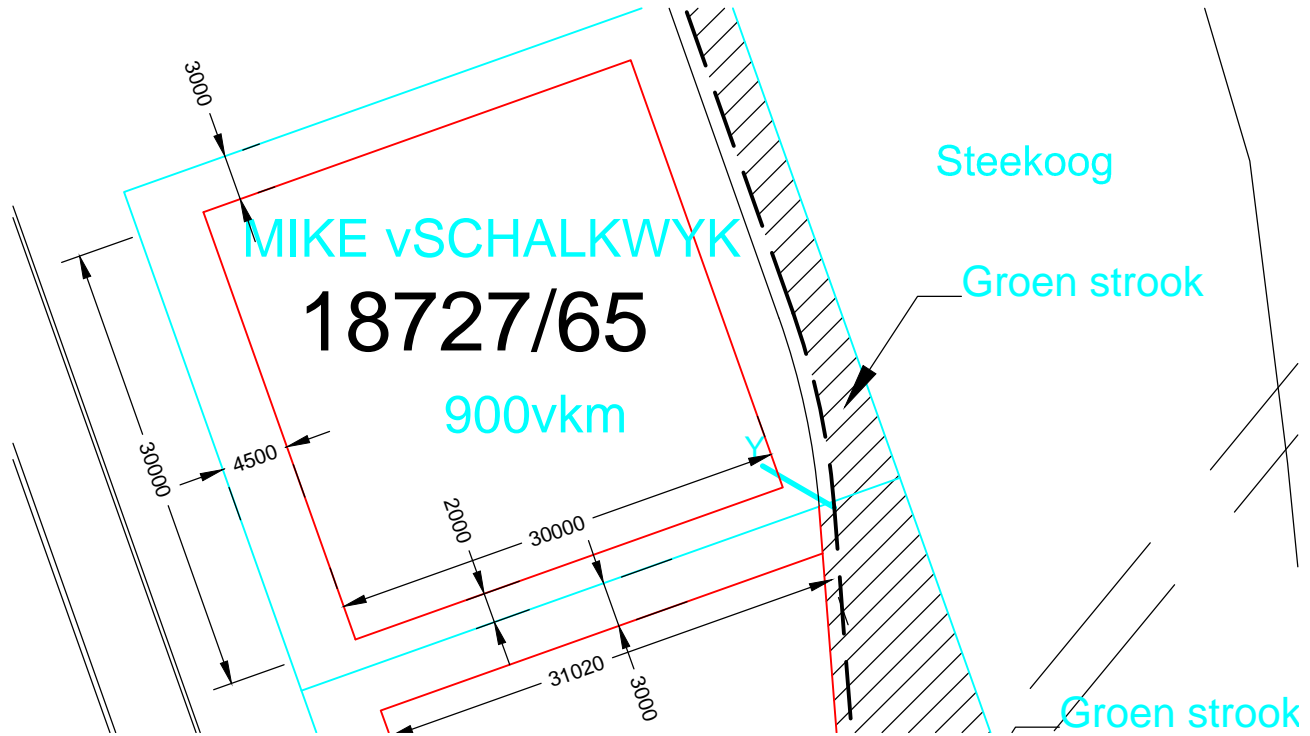

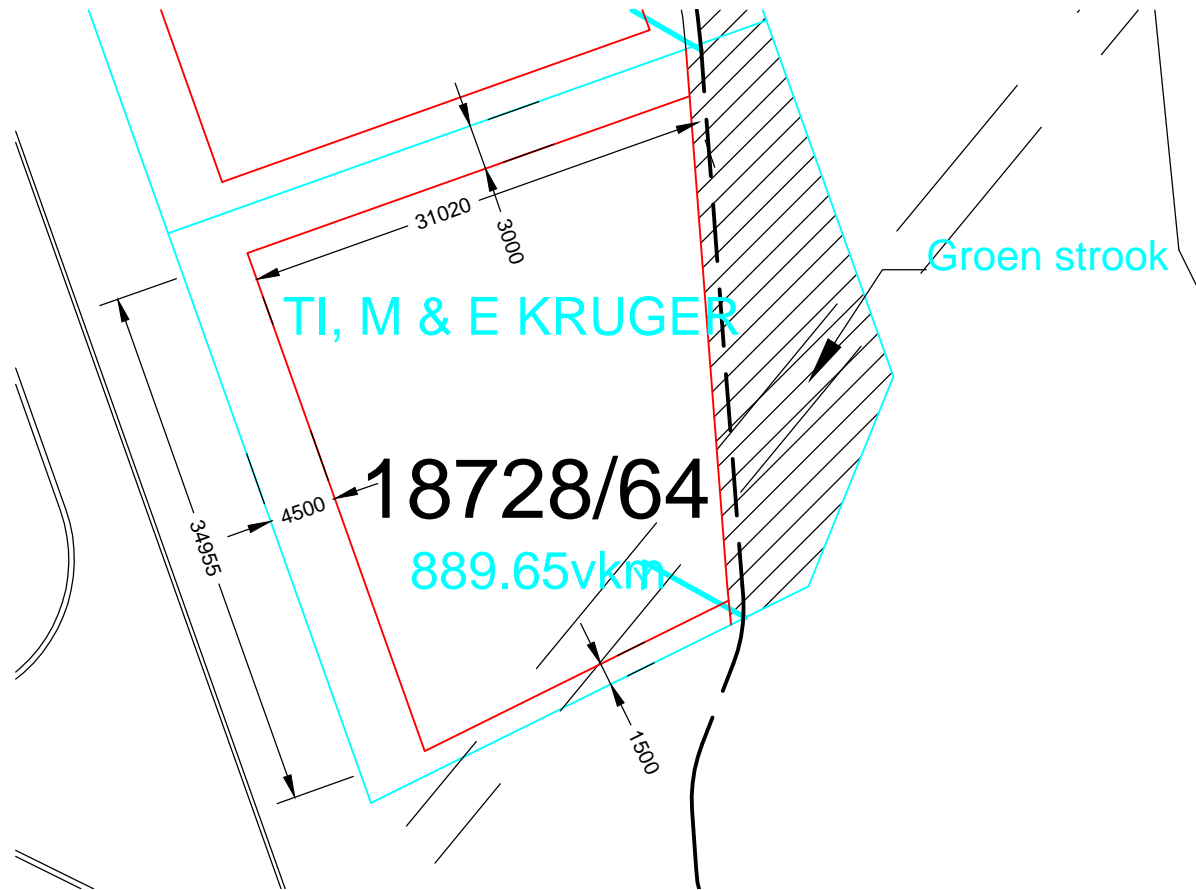

TI, M & E KRUGER

18728/64

889.65vkm

Groen strook

31020  
3000

34955

4500

1500

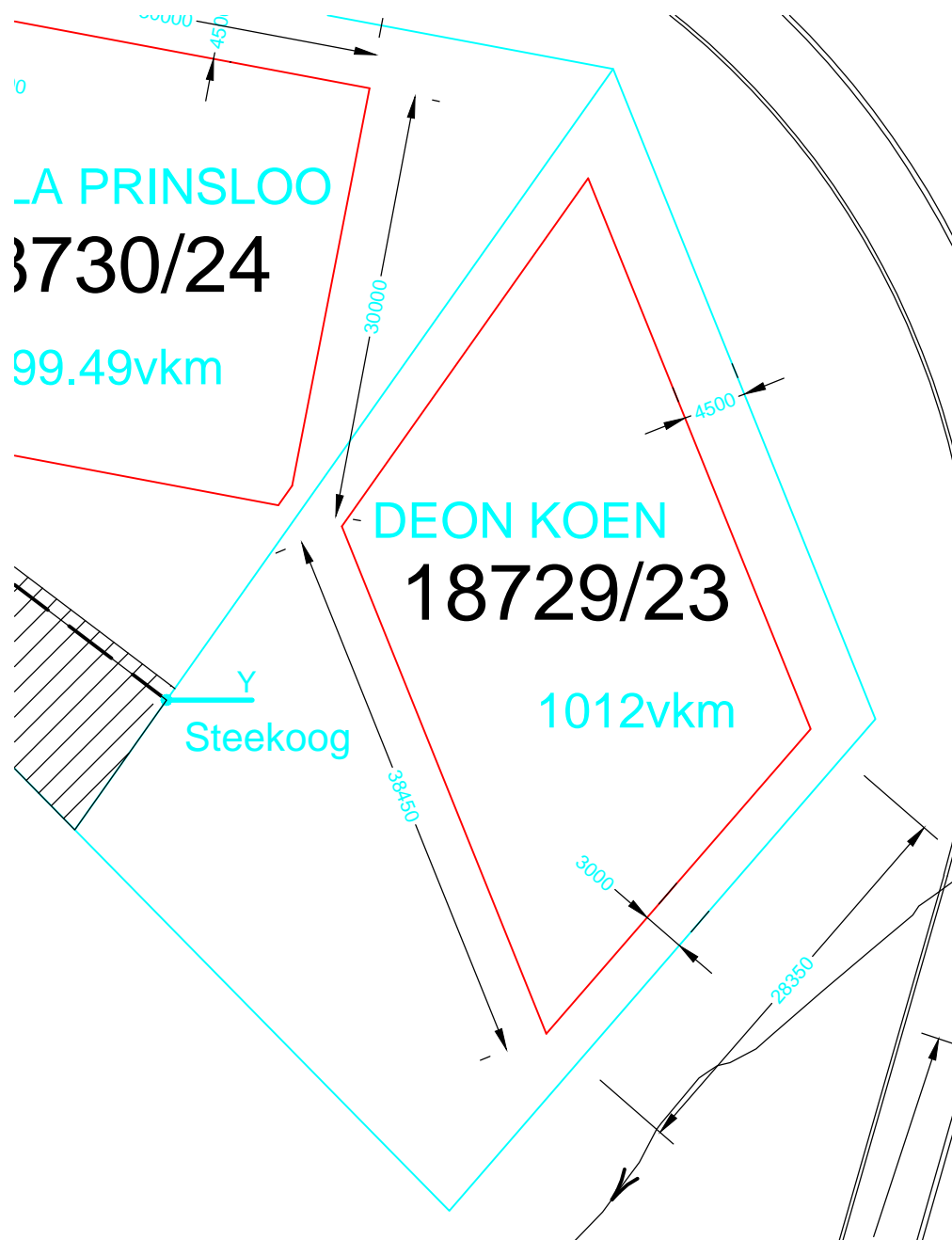

LA PRINSLOO

3730/24

99.49vkm

DEON KOEN

18729/23

1012vkm

Y  
Steekoog

3000

450

30000

4500

38450

3000

28350

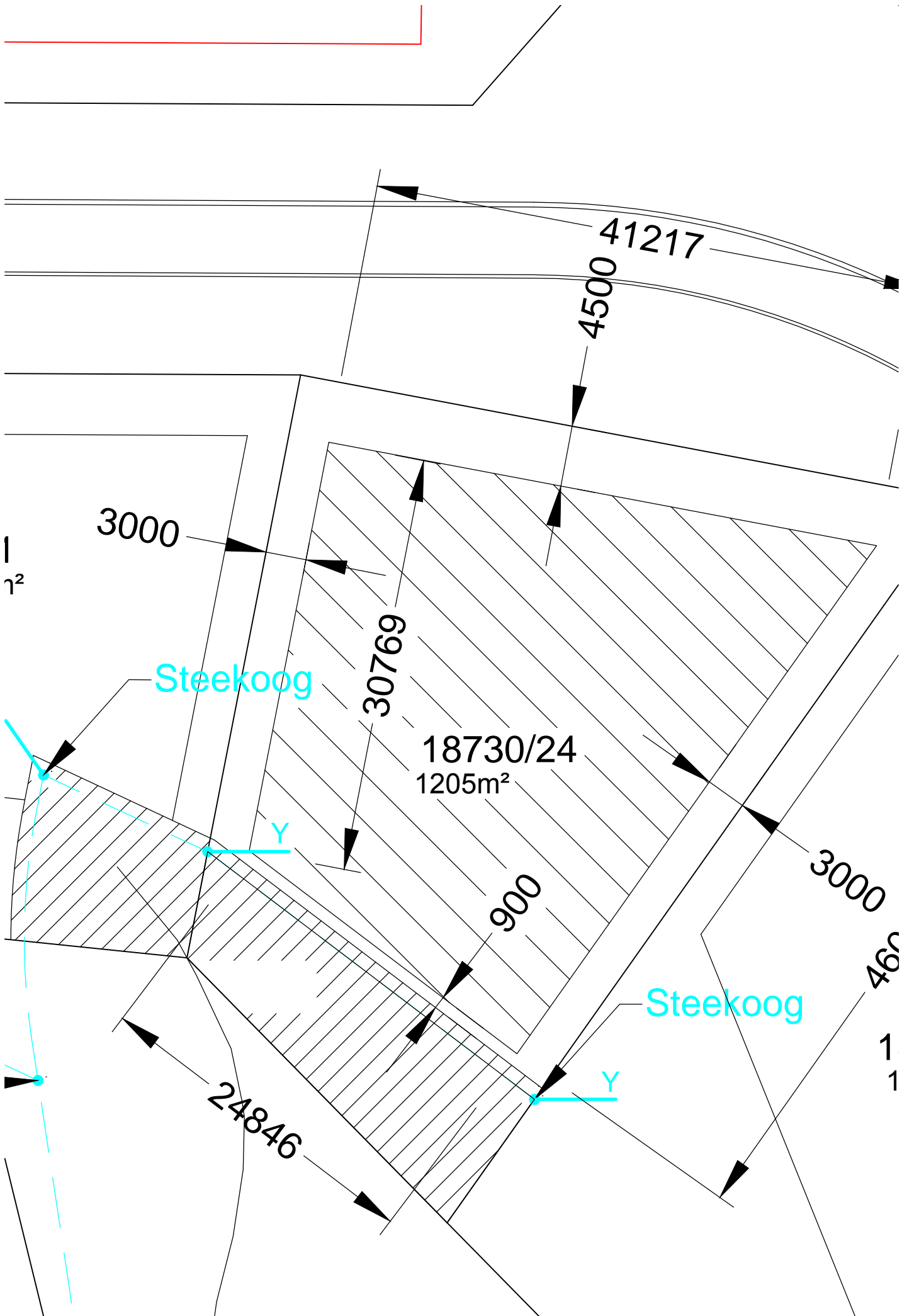

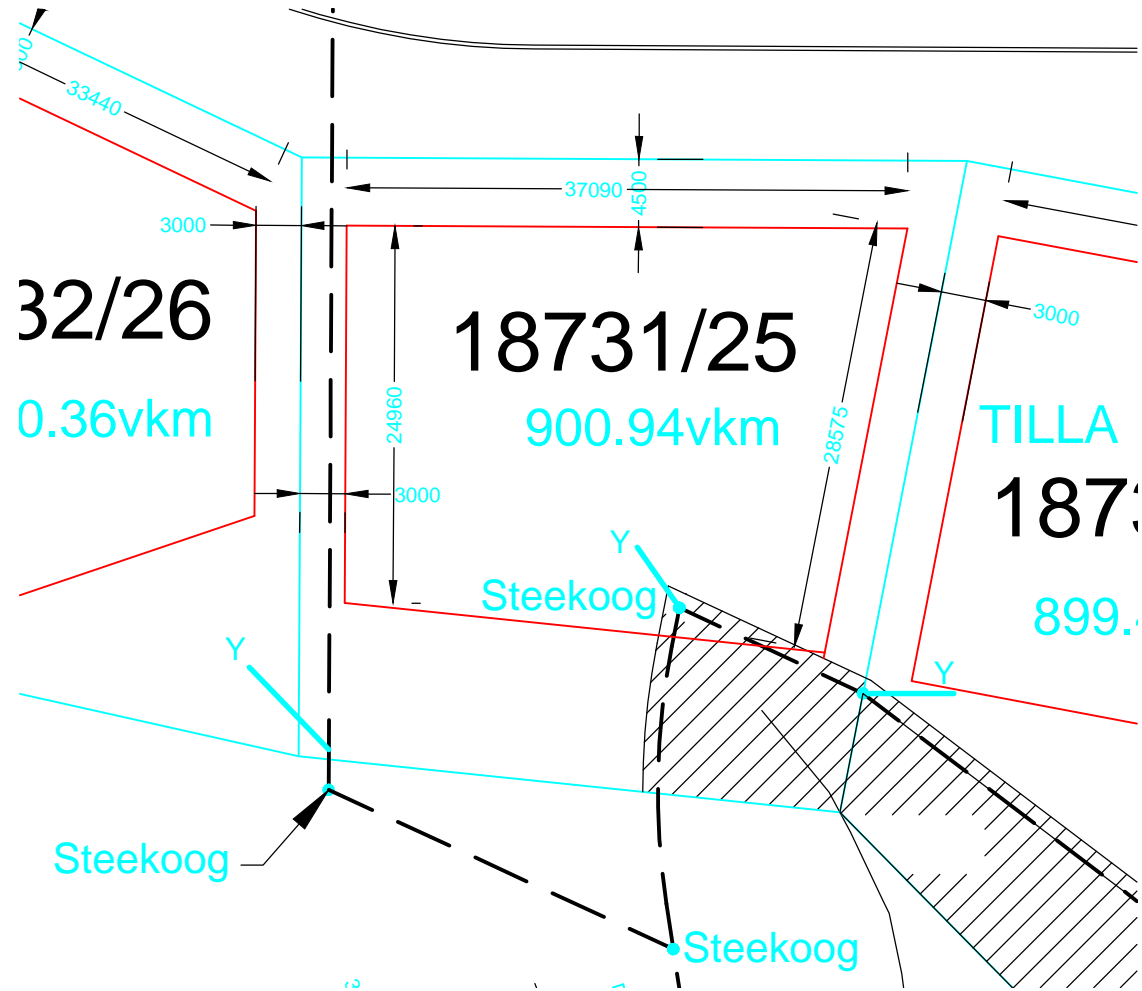





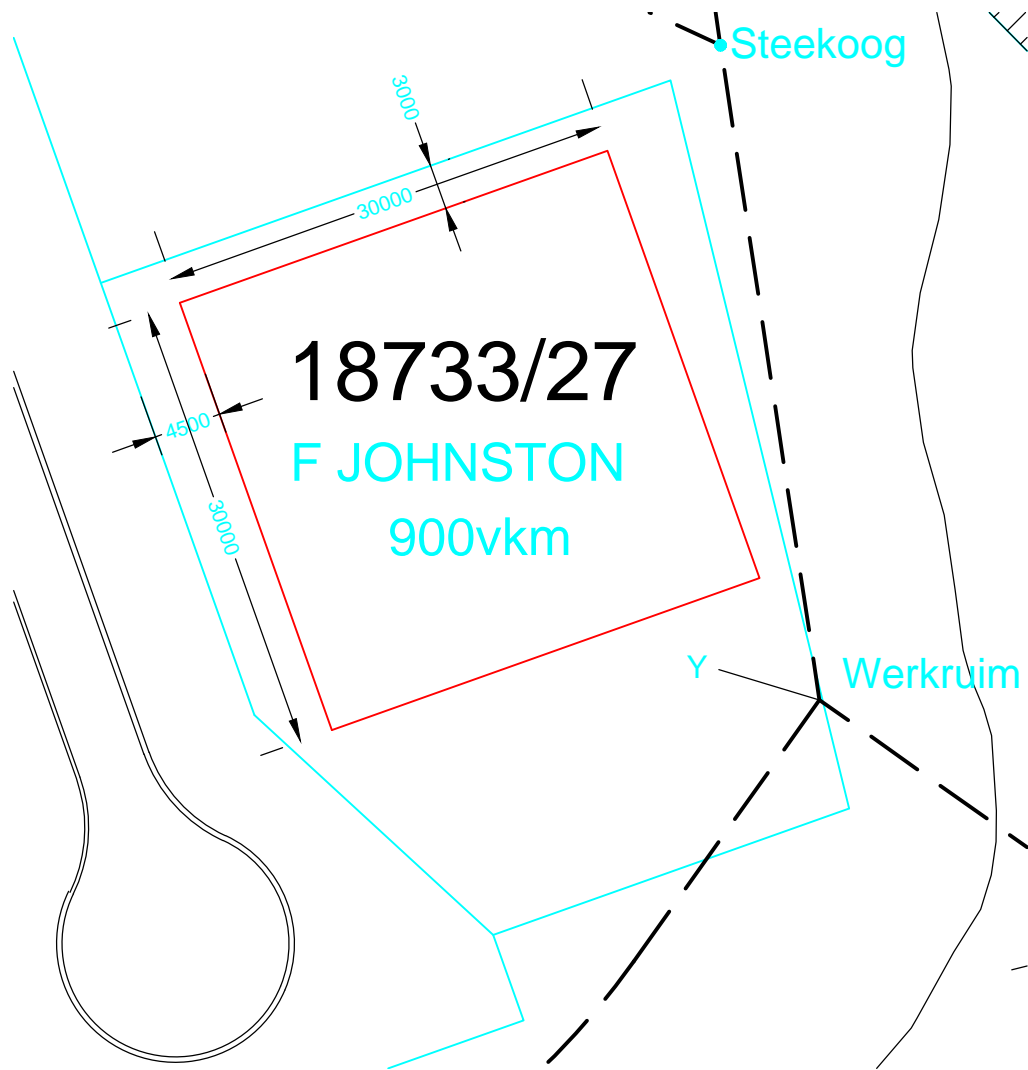

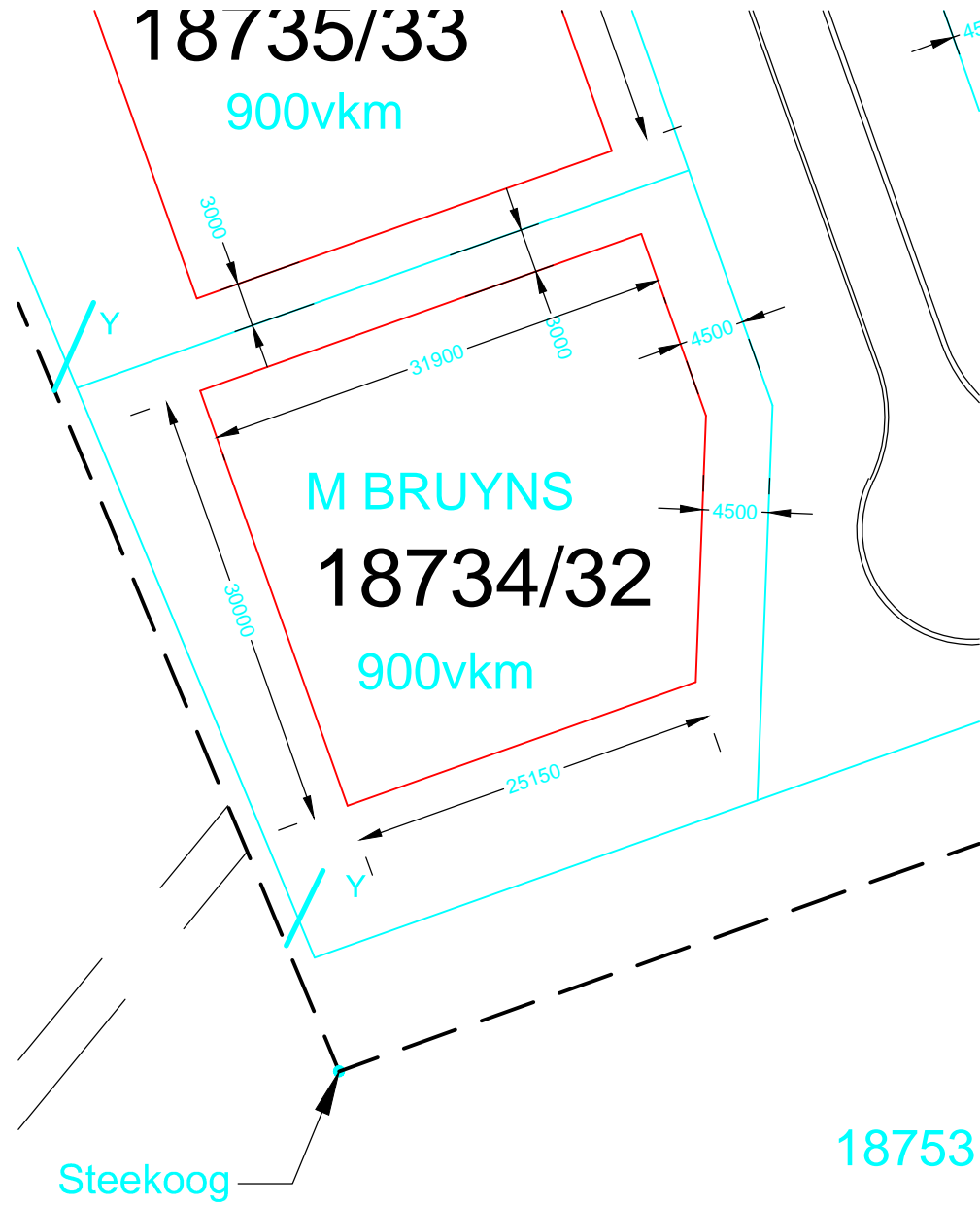

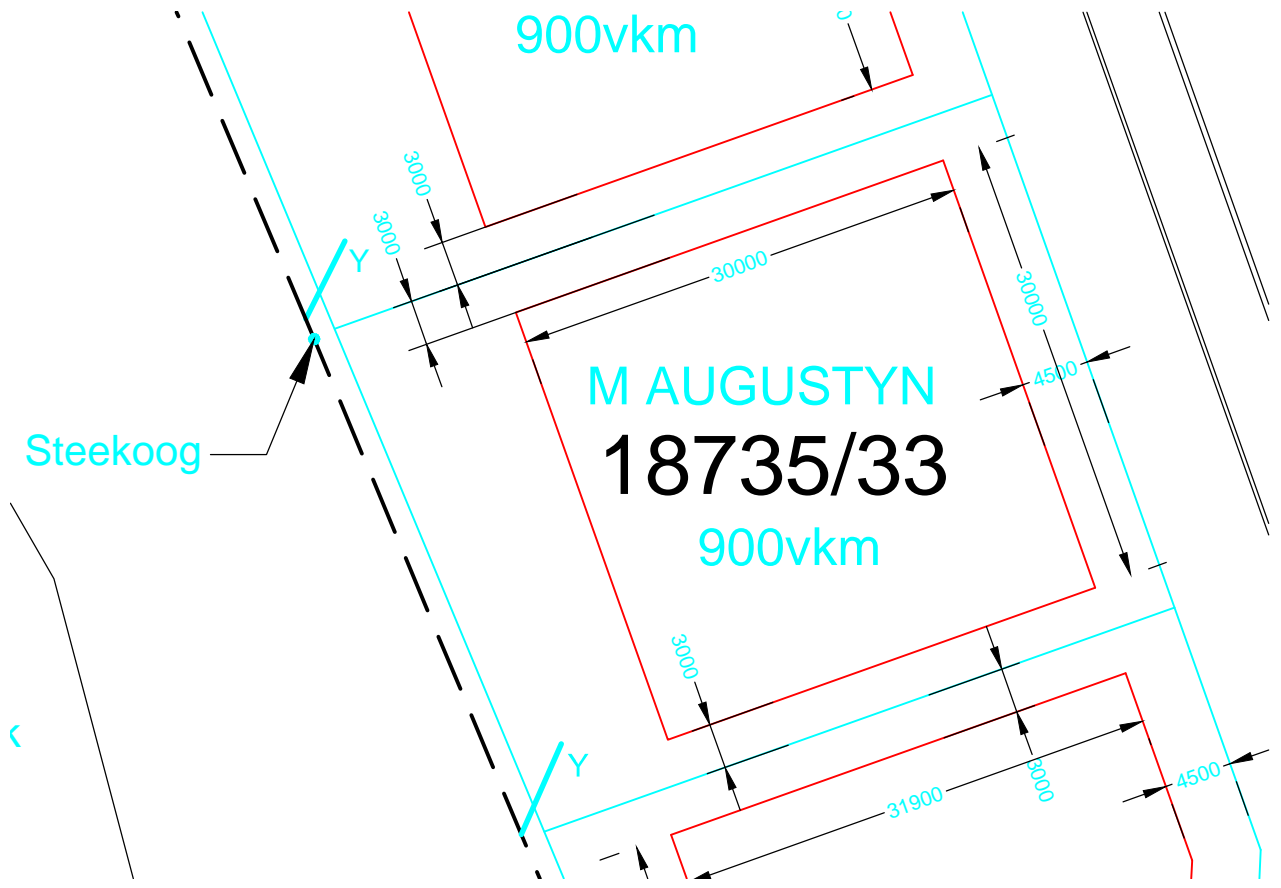

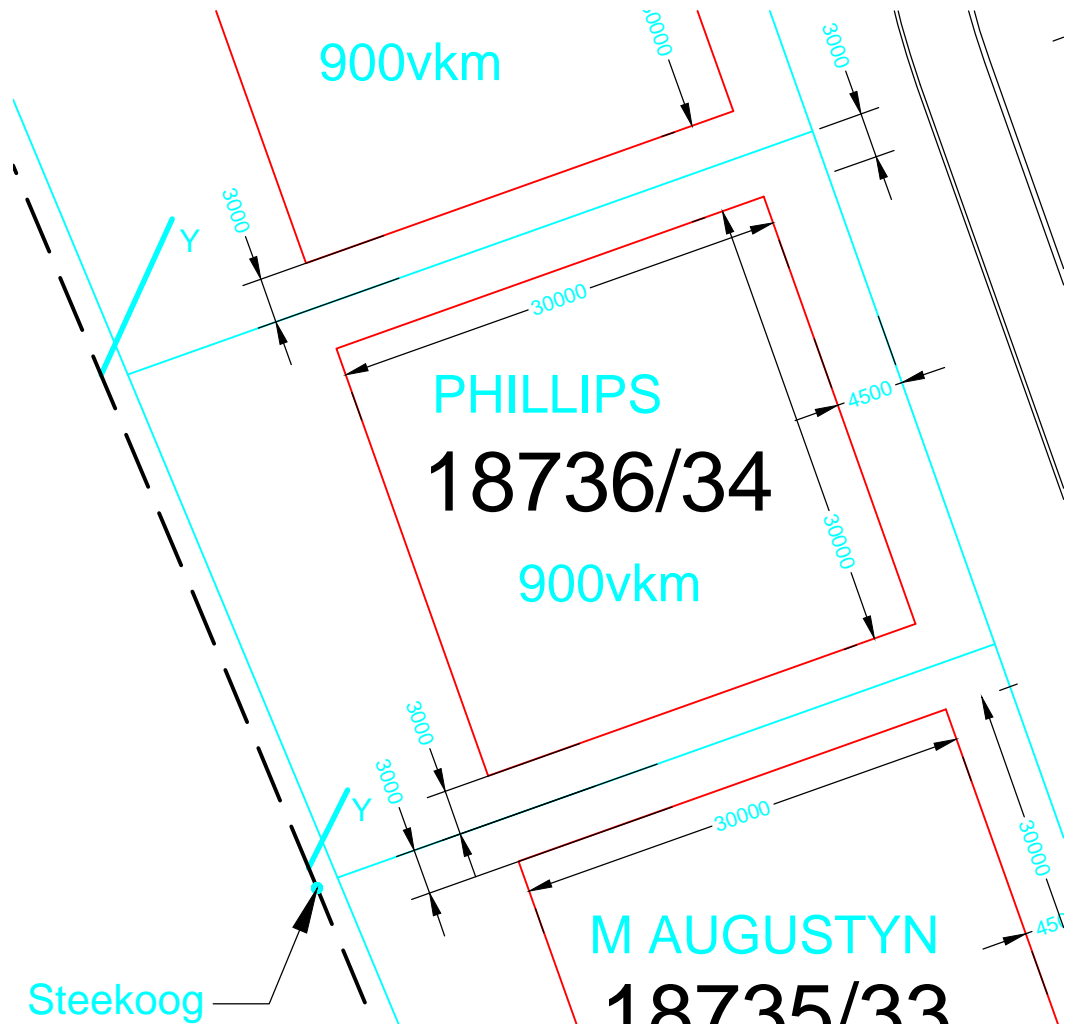

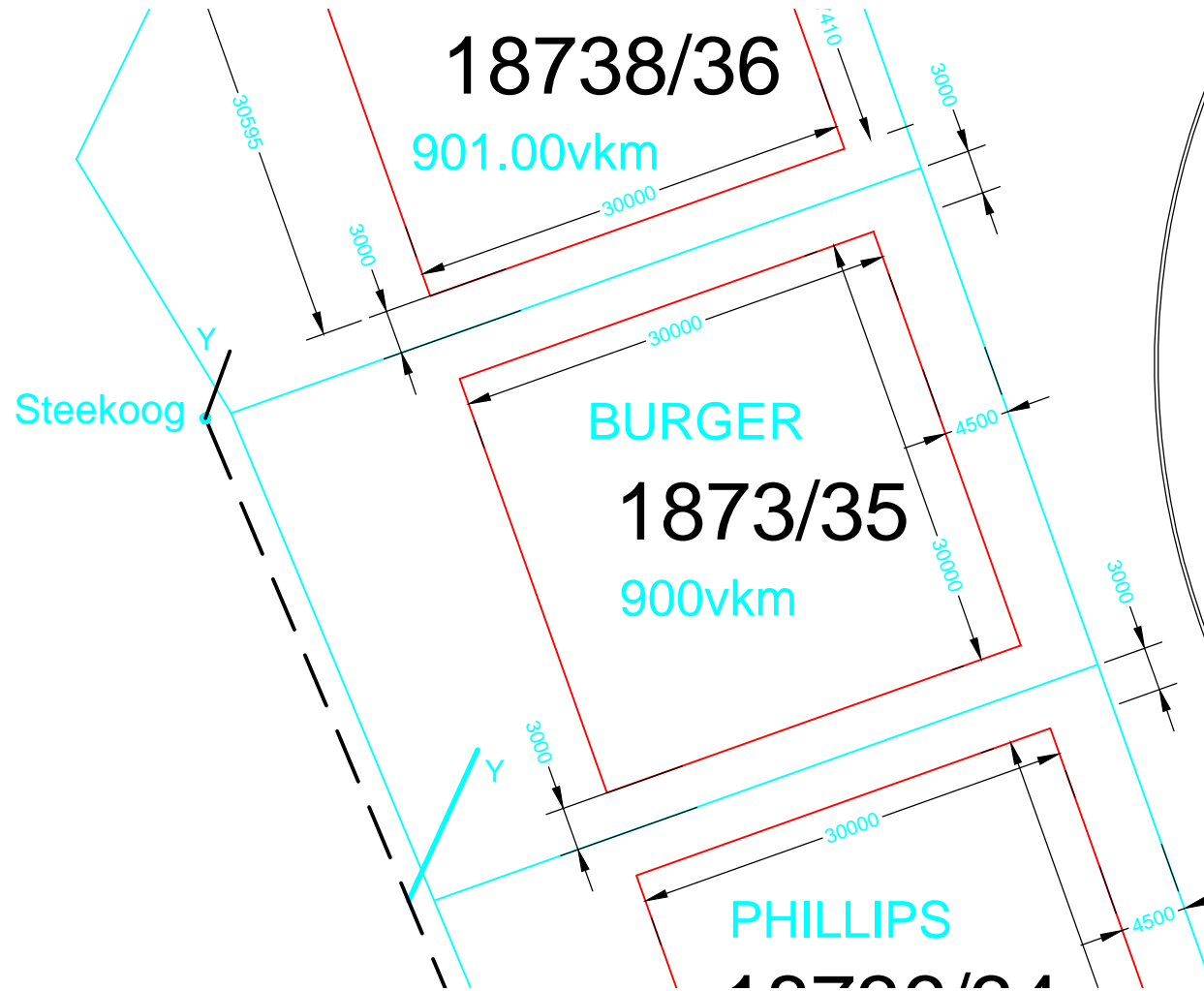

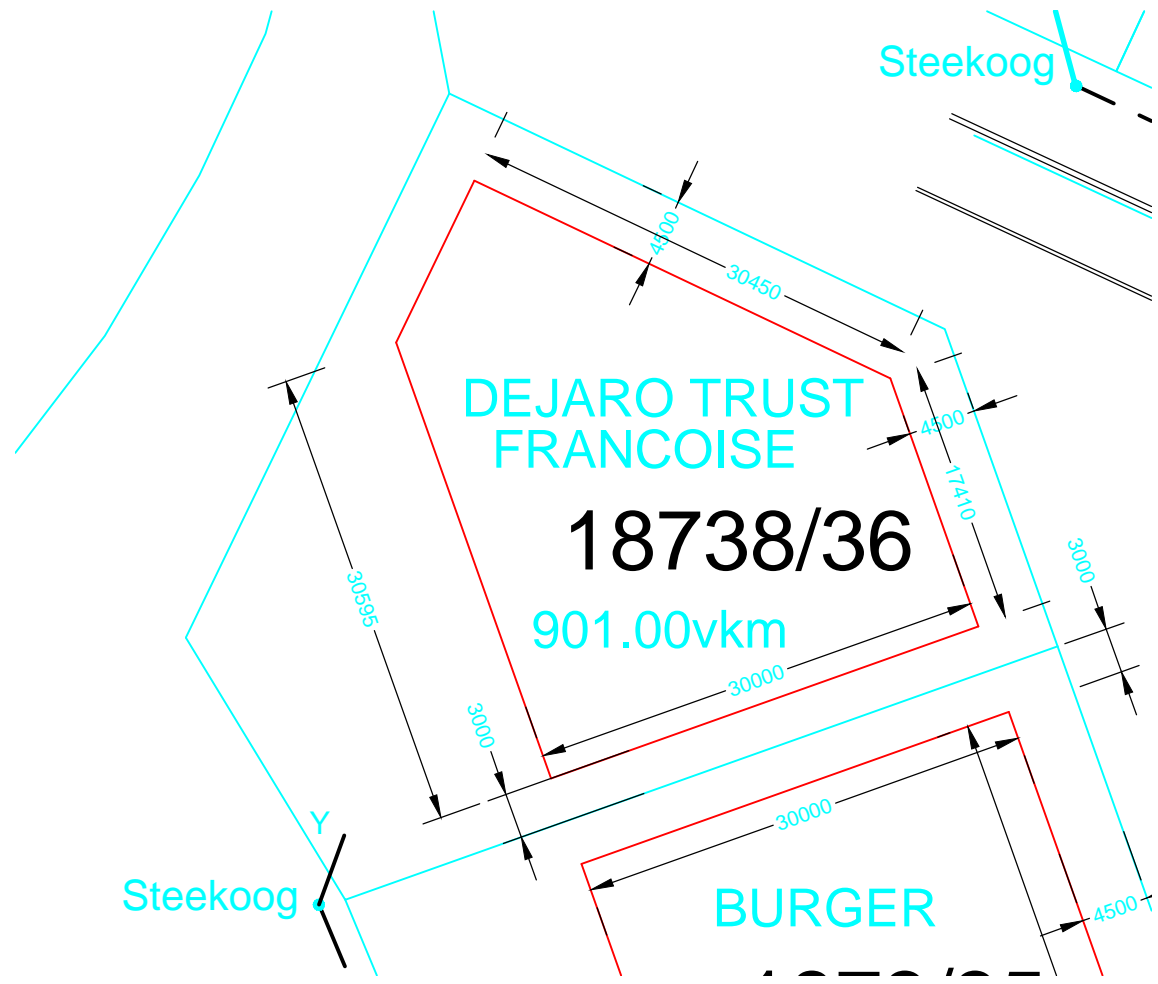

DEJARO TRUST  
FRANCOISE

18738/36

901.00vkm

BURGER

Steekoog

Steekoog

Y

30595

30450

4400

4400

17410

3000

30000

3000

30000

4500

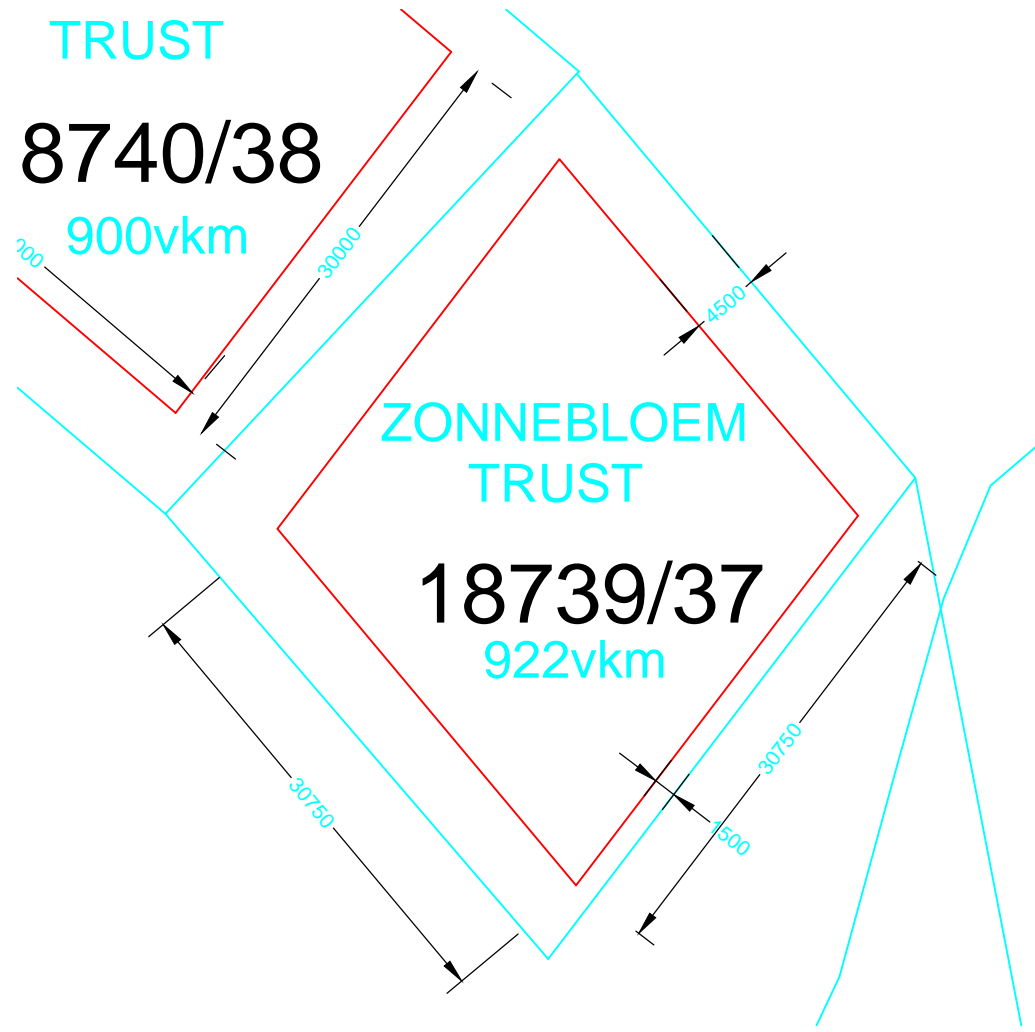

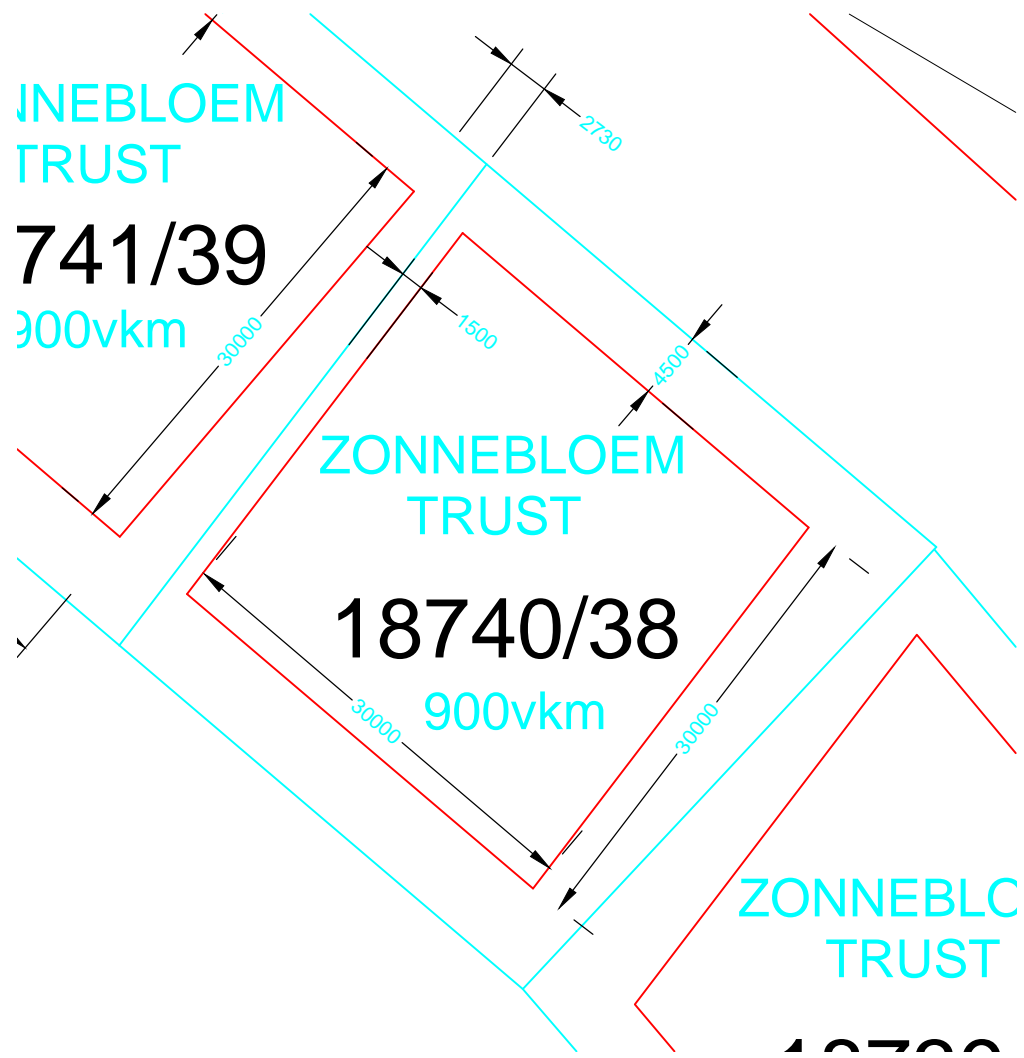



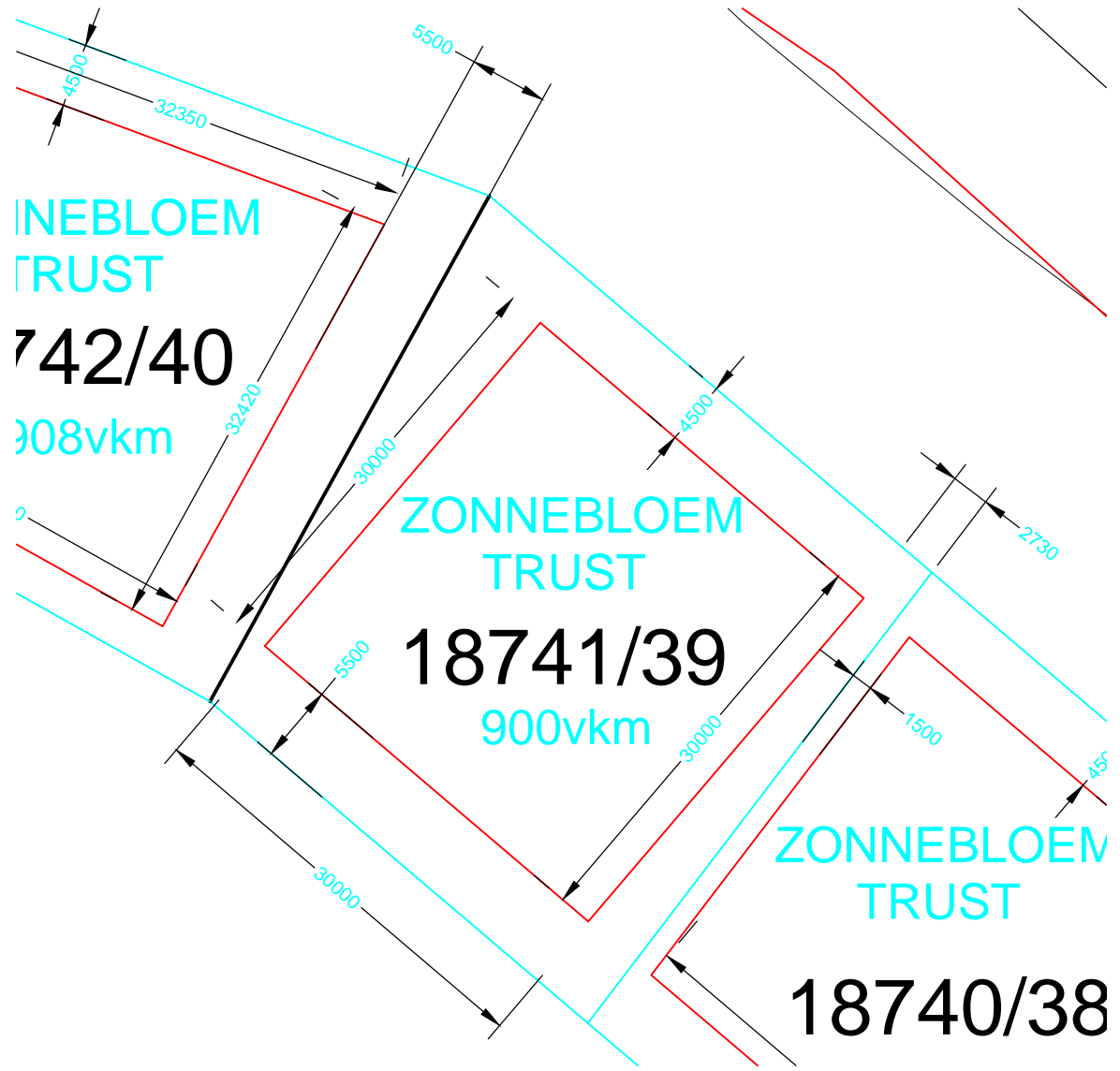

ZONNEBLOEM  
TRUST

742/40

308vkm

ZONNEBLOEM  
TRUST

18741/39

900vkm

ZONNEBLOEM  
TRUST

18740/38

ZONNEBLOEM  
TRUST

43/41

900vkm

ZONNEBLOEM  
TRUST

18742/40

908vkm

ZONNEB  
TRUS

18741

900vk

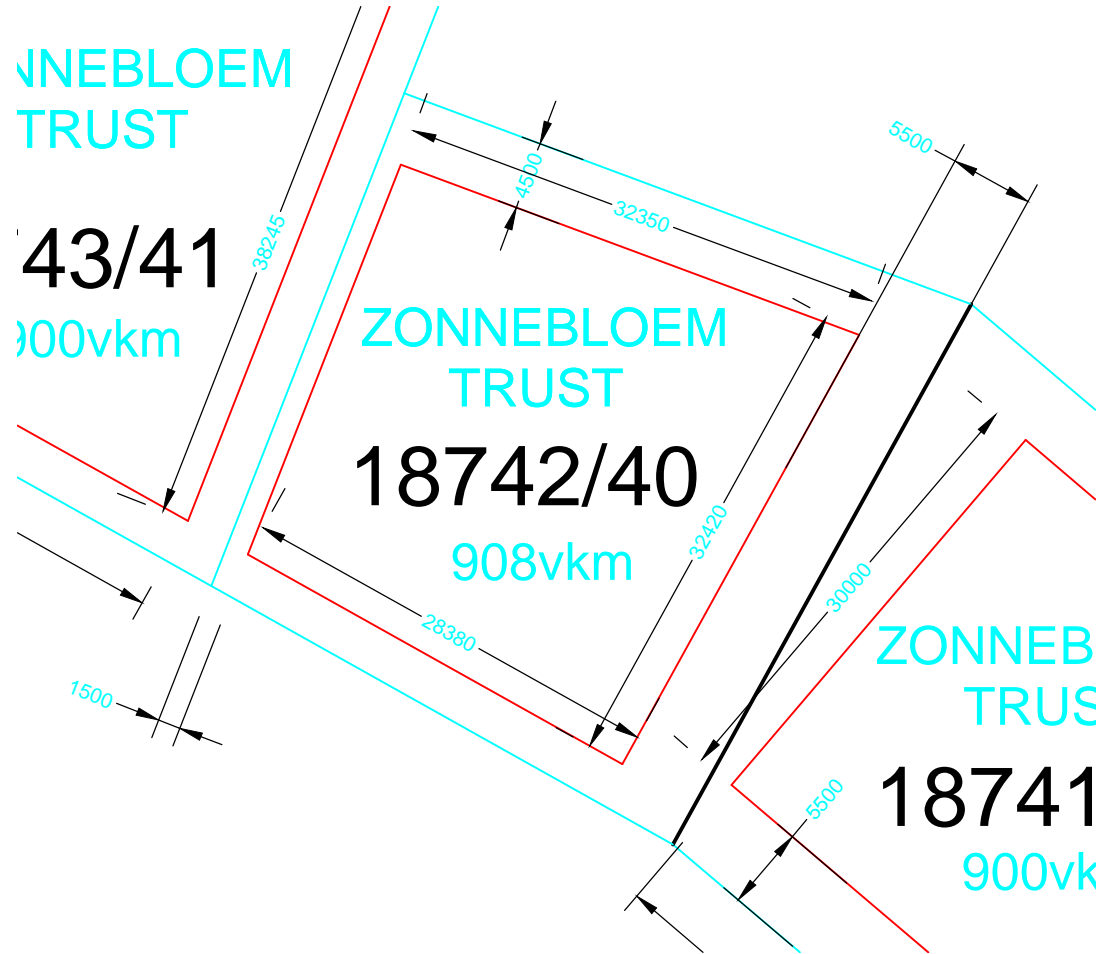

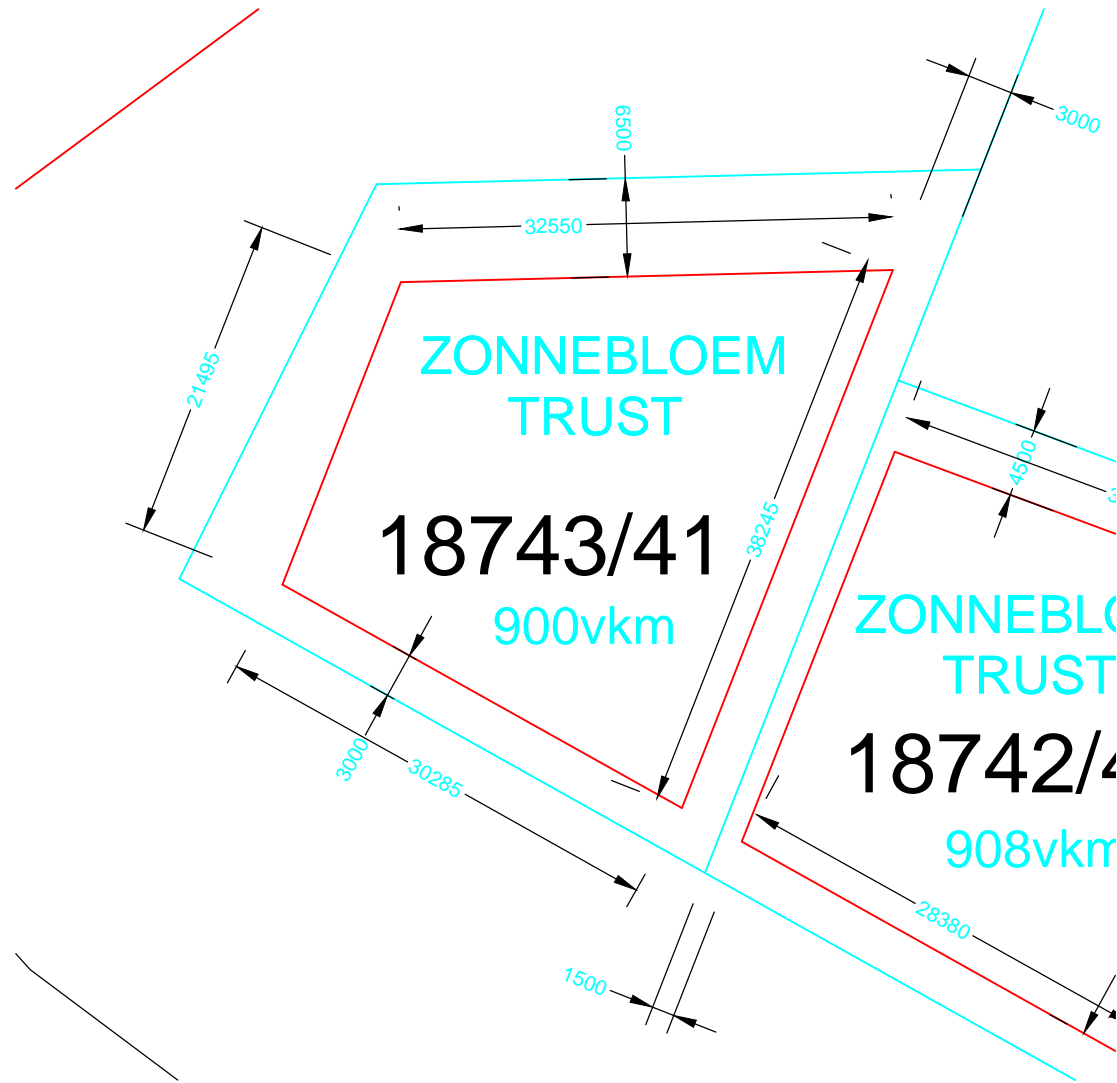

ZONNEBLOEM  
TRUST  
18744

18744/42  
900vkm

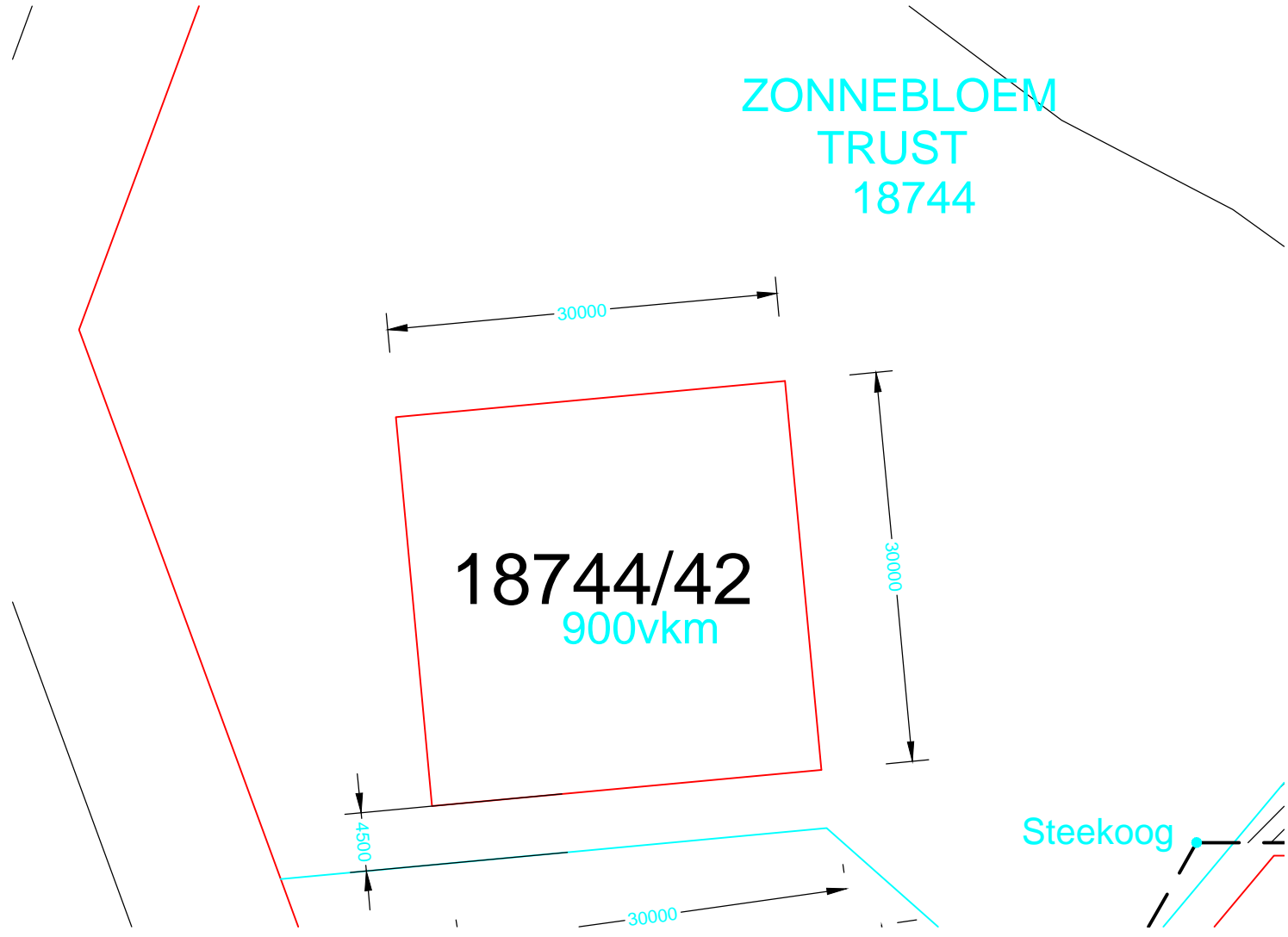

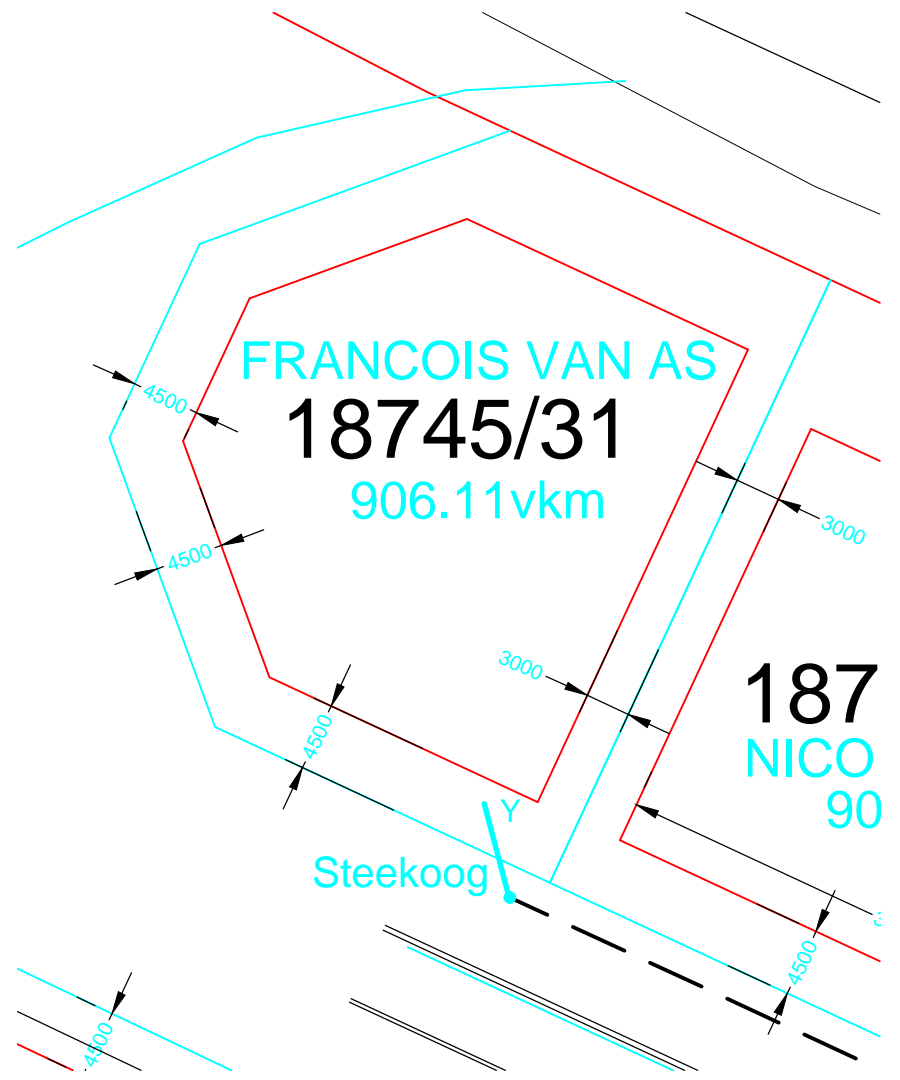

FRANCOIS VAN AS  
18745/31  
906.11vkm

18746/30  
NICO MARAIS  
900vkm

GUY  
1874  
900

